

This Information Is Provided By
CBTricks.com

Craig L201 Service Manual

Liability of damages to any equipment is the sole responsibility of the user! Downloading, viewing, or using any information provided on these pages automatically accepts the user to the terms of this agreement!

Modifications are provided for information purposes only!

Supporters of CBTricks.com paid for the hosting so you would have this file.

CBTricks.com is a non-commercial personal website was created to help promote the exchange of service, modification, technically oriented information, and historical information aimed at the Citizens Band, GMRS (CB "A" Band), MURS, Amateur Radios and RF Amps.

CBTricks.com is not sponsored by or connected to any Retailer, Radio, Antenna Manufacturer or Amp Manufacturer, or affiliated with any site links shown in the links database. The use of product or company names on my web site is not endorsement of that product or company.

The site is supported with donations from users, friends and selling of the Site Supporters DVD's to cover some of the costs of having this website on the Internet instead of relying on banner ads, pop-up ads, commercial links, etc. Thus I do not accept advertising banners or pop-up/pop-under advertising or other marketing/sales links or gimmicks on my website.

ALL the money from donations is used for CBTricks.com I didn't do all the work to make money (I have a day job). This work was not done for someone else to make money also, for example the ebay CD sellers.

All Trademarks, Logos, and Brand Names are the property of their respective owners.

This information is not provided by, or affiliated in any way with any radio or antenna Manufacturers.

Thank you for any support you can give.

For information on how to Support CBTricks.com

<http://www.cbtricks.com/support/>

SERVICE MANUAL

CRAIG®

L201

40 CHANNEL BASE STATION CB TRANSCEIVER



WARNING

Replacement or substitution of IC's, crystals, transistors, regulator diodes, or any other part of a specialized nature with parts other than those recommended by Craig may cause the operator to be in violation of the Type Acceptance requirements of Part 2 of the Rules.

FCC Rules require that ALL transmitter section adjustments, other than those supplied by Craig as operating controls, be made by or under the immediate supervision of the holder of an FCC First or Second Class Radio-Telephone Operator's License.

SPECIFICATIONS

GENERAL

CHANNELS	40 AM
FREQUENCY RANGE	26.965 to 27.405 MHz
FREQUENCY STABILITY	+130 Hz
MICROPHONE	Dynamic type
POWER SOURCE	120 V 60 Hz or 13.8 V dc
CURRENT DRAIN:Receive;	0.95 A at maximum audio output
Transmit;	0.7 A at standby 1.6 A

TRANSMITTER

RF POWER OUTPUT	4.0 W
FREQUENCY TOLERANC	±0.003 % from -30 C to +50 C
SPURIOUS ATTENUATION	60 dB minimum
OUTPUT IMPEDANCE	50 Ohm

NOTE: ALL DATA SUBJECT TO CHANGE WITHOUT NOTICE

RECEIVER

SENSITIVITY	Better than 0.5 uV for 10 dB (S+N)/N
BANDWIDTH	6 KHz @ -6.0 dB
AGC	Change in audio output less than 10 dB from 10 uV to 1.0 V
SQUELCH	Adjustable, threshold less than 0.5 uV Tight, more than 250 uV
POWER OUTPUT	3.0 W at 10 % THD
IMAGE REJECTION	Better than 70 dB
IF REJECTION	Better than 60 dB
ADJACENT CHANNEL REJECTION	Better than 55 dB
IF FREQUENCY	10.695 MHz
DELTA TUNE RANGE	+1250 Hz
NOISE BLANKER	RF parallel gate type

P.A. SYSTEM

POWER OUTPUT	3.0 W
--------------	-------

PARTS PRICE LIST

REF. No.	CRAIG KEY No.	DESCRIPTION	MFR's SUGG RET. PRICE
PACKAGING			
	L201001	Individual Carton	5.50
	L201002	Styrofoam Set (L & R)	3.50
	L103507	Microphone (Complete)	22.40
	L201003	Mic Mounting Kit	1.20
	L150396	Bracket, Mic Mounting	.75
	-----	RH Tapp Screw M3.5x8	.25
	-----	Star Washer M3.5	.25
	XFU002	Spare Fuse, 2A	1.00
	4101033	D.C. Power Cord w/Plug	3.50
CABINET & CHASSIS			
1	NSP	Cabinet Top	----
2	L103100	Wool Tack	.25

SUBJECT TO CHANGE WITHOUT NOTICE. USE ALL AVAILABLE NUMBERS AND COMPLETE DESCRIPTION WHEN ORDERING, INCLUDING MODEL NUMBER

THESE PRICES HAVE BEEN REVISED AS OF 6/20/80

REF. No.	CRAIG KEY No.	DESCRIPTION	MFR's SUGG RET. PRICE
CABINET & CHASSIS (continued)			
3	L201010	Assy, Front Escutcheon	24.15
4	NSP	Plate, TX/RX/CH 9	----
5	NSP	Plate, Sw Control Index	----
6	NSP	Plate, Control Board Index	----
7	L201070	Optical Filter (CLK & CH Display)	4.15
8	L201490	Speaker Dust Cloth	.25
9	NSP	Cabinet Bottom	----
10	L201800	Front Foot	.25
11	L201801	Rear Foot	.25
12	-----	PH Tapp Screw M3x14	.25
13	-----	PH Tapp Screw M3x12	.25
14	NSP	Cabinet Back	----
15	NSP	Chassis	----
16	NSP	Heat Sink	----

A PRODUCT OF CRAIG CORPORATION

ALIGNMENT PROCEDURES

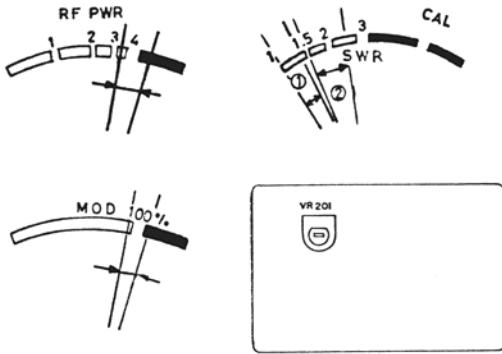

Test Equipment Required

- a) OSCILLOSCOPE
- b) D.C. VOLT METER
- c) VTVM
- d) RF WATTAGE METER
- e) FREQUENCY COUNTER
- f) 50 Ohm DUMMY ANTENNA LOAD
- g) SIGNAL GENERATOR

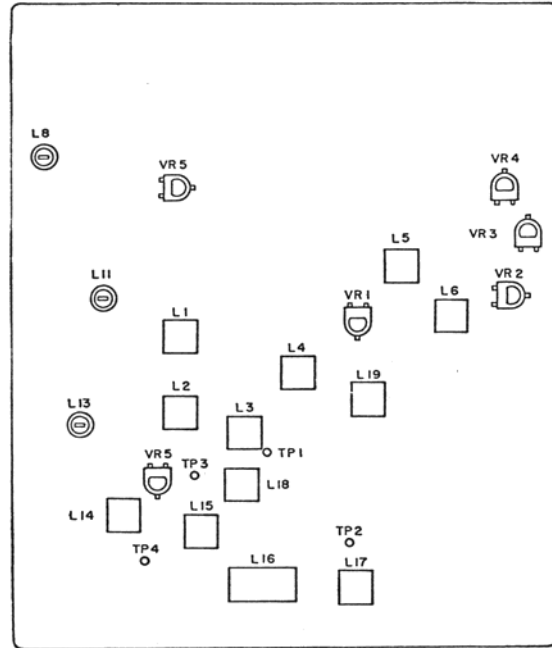

STEP	SET TO	CONNECTIONS	ADJUST	ADJUST FOR
P.L.L. CIRCUIT				
1	Channel 40. No Modulation. TX Mode.	D.C. Volt Meter To Pin #7 Of IC1 (TP1).	L17	Reading Of Approx. 3.5 V On D.C. Volt Meter.
2	Channel 1. No Modulation. TX Mode.	Oscilloscope To Secondary Of L18 (TP3).	L18	Maximum Indication On Oscilloscope.
TRANSMITTER				
1	Channel 19. No Modulation. TX Mode.	RF Wattage Meter To Antenna Jack (J301). VTVM To TP4.	L15, L16	Maximum Indication On VTVM.
2	Same As Step 1	RF Wattage Meter To Antenna Jack (J301).	L11, L13, L14	Maximum Indication On RF Wattage Meter.
3	Same As Step 1	Same As Step 2.	L11	Nominal 3.8 W On RF Wattage Meter.
4	Repeat Steps 1,2 & 3 To Insure That Adjustments Made Are Correct.			
5	Channel 19. TX Mode. 1KHz (100 mV) Applied Through Mic Input.	Signal Generator To Microphone Jack (J451). Oscilloscope To Antenna Jack (J301) Through 50 Ohm Load And Attenuator.	VR6	95 % Modulation.
6	Same As Step 1	RF Wattage Meter To Antenna Jack (J301).	VR4	"RF" Mark Reading On Meter (M201).
7	Same As Step 1	Frequency Counter To Antenna Jack (J301) Through 50 Ohm Load And Attenuator.	L19	27.185 MHz On Frequency Counter.
NOTE; Under Same Set-Up, Check All Channels For Correct Frequency Operation.				
8	Same As Step 5	Same As Step 5.	VR5	95 % Modulation.
RECEIVER				
1	Volume;MAX. Squelch;MIN. ANL;OFF	Signal Generator To Antenna Jack (J301) At Channel 19 Frequency (27.185 MHz). VTVM To EXT. SPKR. Jack (J402)	L1,L2,L3 L4,5,6	Maximum Audio Output
2	Same As Step 1	Same As Step 1.	VR1	2 V Output With S/G Output Level Of .4uV.
3	Volume;MAX. Squelch;MAX. ANL;OFF	Same As Step 1.	VR3 (Squelch)	2 V Output With S/G Output Level Of 250uV.
4	Same As Step 1	Same As Step 1.	VR2	Reading Of 9 On Signal Meter (M302) With S/G Output Level Of 100uV.

REF. No.	CRAIG KEY No.	DESCRIPTION	MFR's SUGG RET. PRICE
CABINET & CHASSIS (continued)			
17	NSP	Heat Sink	----
18	NSP	Heat Sink	----
19	NSP	Holder, Meter Lamp	----
20	L201395	Mounting Strap (Transformer)	.25
21	NSP	Escutcheon Mounting Bracket (R)	----
22	NSP	Escutcheon Mounting Bracket (L)	----
23	NSP	Holder, Sw Assy	----
24	NSP	Holder, Sw Assy	----
25	L201212	Square Nut M3	.25
26	L103026	Knob, CHANNEL SELECT	1.40
27	L103027	Knob, VOL Cont; SQUELCH Cont; etc.	.90
28	L103028	Pushbutton, POWER/CLOCK SET Sw	.65
29	L201396	Holder Bracket, CH Select Sw	.50
30	NSP	Model No./FCC/Serial No. Plate	----
31	L201430	Cushion (Meter Top)	.25
32	L201431	Cushion (Meter Bottom)	.25
33	L201491	Dust Cloth, CH 9/PA/ANL/NB Sw	.25
34	L201492	Dust Cloth, YR/DB/SWR Sw	.25
35	L103291	Spring Plate, Ch. Select Knob	.25
36	NSP	Rivet	----
37	-----	Hex Nut M3	.25
38	3307079	Bushing, AC Cord	.35
39	L201231	PCB Mtg Stud	.40
40	-----	Plastic PH Screw M3x6	.25
41	-----	FH Screw M3x6	.25
42	-----	PH Screw M2x4	.25
43	-----	PH Screw M2.6x4	.25
44	-----	PH Screw M3x6	.25
45	-----	PH Screw M4x10	.25
46	-----	PH Screw M3x8	.25
47	-----	PH Screw M5x8	.25
48	-----	PH Tapp Screw M3x6	.25
49	-----	PH Tapp Screw M3x8	.25
50	-----	PH Tapp Screw M3x6	.25
51	-----	Flange Nut M4	.25
52	L201232	Rubber Spacer	.25
53	L201330	Headphone Jack Bushing	.25
54	-----	Washer	.25
55	NSP	Holder(R), CLOCK LED PCB	----
56	NSP	Holder(L), CLOCK LED PCB	----
57	NSP	Ground Lug	----
58	NSP	Heat Sink	----
59	NSP	Ground Lug	----
C204	-----	Capacitor 2200uF/35V	1.50
D301	TLR124	LED, TX Indicator	.85
D302	TLG124A	LED, RX Indicator	1.35
D303	TLR124	LED, CH 9 Indicator	.85
D501	UR202	LED, DIGITAL CH DISPLAY	9.15
D701	TLR2077	LED, DIGITAL CLOCK DISPLAY	13.30
FH002	L201380	Fuse Holder	.30
IC3	TA7222P	I.C. (AF POWER AMP)	5.65
J301	L103607	Connector, Coaxial Antenna	1.80
J302	4101027	Socket, D.C. Pwr Connector	1.75
J401	4101034	Socket, PA Spkr Jack	1.45
J402	4101034	Socket, Ext. Spkr Jack	1.45
J451	L103608	Socket, 4P Mic Connector	2.15
J601	L201607	Socket, Headphone Jack	2.15
M301	L201604	Meter, SWR/MOD	8.00
M302	L201605	Meter, RF PWR/SIG	8.00
PC311	L201516	PCB w/Comp, HEADPHONE JACK	3.85
PC398	L201517	PCB w/Comp, EXT. SPKR JACK	1.75
PC410	L201518	PCB w/Comp, POWER SUPPLY	12.70
PC433	L201519	PCB w/Comp, LED CH DISPLAY	9.65
PC434	L201520	PCB w/Comp, CLOCK VOLTAGE REG.	5.00
PC435	L201521	PCB w/Comp, CH SELECT SW	9.30
PC443	L201522	PCB Only, CLOCK PUSH SW ASSY	1.50
PC455	L201523	PCB w/Comp, SLIDE SW ASSY	9.35
PC541	L201524	PCB w/Comp, LED CLOCK LOGIC	21.00
PC544	L201525	PCB w/Comp, MIC JACK	3.35
PC546	L201526	PCB w/Comp, TX/RX/CH 9 LED Ind	3.00
PC566	NSP	PCB w/Comp, MAIN	----
PL301	L201550	Pilot Lamp, RF PWR/SIG METER	1.60
PL302	L201550	Pilot Lamp, SWR/MOD METER	1.60
S301	L201530	Slide Sw, CH 9(AUTO)/CB Select	1.90
S302	L201530	Slide Sw, CB/PA Select	1.90
S303	L201530	Slide Sw, ANL On/Off	1.90
S304	L201530	Slide Sw, NB On/Off	1.90
S305	L201531	Slide Sw, MOD/CAL/SWR Select	2.15
S306	L201532	Slide Sw, AC/DC Select	2.15
S501	L103531	Rotary Sw, CHANNEL Select	9.90
SW181	L201533	Push Sw Assy, (S701~S707)	11.95
S701	L201534	Push Sw, MANUAL POWER	2.60
S702	L201534	Push Sw, AUTO POWER	2.60
S703	L103532	Push Sw, AUTO POWER SET	3.30
S704	L103532	Push Sw, CLOCK SET	3.30
S705	L201536	Push Sw, FAST SCAN	3.00
S706	L201536	Push Sw, SLOW SCAN	3.00
S707	L201536	Push Sw, HOLD	3.00
SP301	L201702	Speaker, 16 Ohm/3W	7.70
T301	L201641	P O W E R T R A N S F O R M E R	15.70

NOTE: NSP; Non Serviceable Part

REF. No.	CRAIG KEY No.	DESCRIPTION	MFR's SUGG RET. PRICE
CABINET & CHASSIS (continued)			
TR8	2SC2029	Transistor (TX POWER AMP)	2.90
TR9	2SC2028	Transistor (DRIVER AMP)	1.65
TR201	2SD586	Transistor (VOLTAGE REGULATOR)	3.80
TR801	2SC1096	Transistor (VOLTAGE REGULATOR)	3.40
VR301	L201570	VR 1K, RF GAIN Cont	1.50
VR302	L201571	VR 50K, TONE Cont	1.50
VR303	L201572	VR 50K, VOLUME Cont	1.50
VR304	L201571	VR 50K, SQUELCH Cont	1.50
VR305	L201573	VR 5K, SWR/CAL Cont	1.50
VR306	L201574	VR 20K, DELTA TUNE Cont	1.80
VR307	L201575	VR 5K, MIC GAIN Cont	1.50
WZ022	3307099	A.C. Power Cord	1.50
YY023	NSP	Clamp, Lead Wire	----
YY024	L201331	Bushing	.40
YY025	L201332	Bushing	.40
YY049	L201381	Holder, Lead Wire	.25
REF. No.	CRAIG KEY No.	DESCRIPTION	MFR's SUGG RET. PRICE
COILS, TRIMMERS & XFORMERS			
FL1	L103670	Ceramic Filter (FL048)	1.40
FL2	L103671	Ceramic Filter (FL066)	6.45
L1	L104670	Trimmer (LA029)	.90
L2	L104671	Trimmer (LA138)	.90
L3	L103675	Trimmer (LA181)	.90
L4	L103675	Trimmer (LA181)	.90
L5	L103678	Trimmer (LA204)	.85
L6	L103679	Trimmer (LA207)	.85
L7	L105670	Coil (LD113)	1.80
L8	L103684	Trimmer (LC072)	.80
L9	L104674	Coil (LE096)	.25
L10	L103687	Coil (LE093)	.25
L11	L103686	Trimmer (LC073)	.75
L12	L103685	Coil (LD033)	.40
L13	L103684	Trimmer (LC072)	.80
L14	L103683	Trimmer (LA208)	.90
L15	L104679	Trimmer (LA088)	.90
L16	L104680	Trimmer (LA198)	1.75
L17	L104677	Trimmer (LA165)	.90
L18	L104678	Trimmer (LA201)	.90
L19	L105671	Trimmer (LA218)	.95
L20	L105672	Coil (LD077)	.25
T1	L103641	Output Transformer (TF177)	3.55
T2	L103642	AF Choke Coil (TF083)	1.05
T301	L201641	P O W E R T R A N S F O R M E R	15.70
MISCELLANEOUS ELECTRICAL			
F301	XFU002	Fuse, 2A	1.00
F302	XFU002	Fuse, 2A	1.00
J301	L103607	Connector, Coaxial Antenna	1.80
J302	4101027	Socket, D.C. Power Conn.	1.75
J401	4101034	Socket, PA Spkr Jack	1.45
J402	4101034	Socket, Ext Spkr Jack	1.45
J451	L103608	Socket, 4P Mic Connector	2.15
J601	L201607	Socket, Headphone Jack	2.15
M301	L201604	Meter, SWR/MOD	8.00
M302	L201605	Meter, RF POWER/SIG	8.00
MIC1	L103507	Microphone (Complete)	22.40
P302	4101033	D.C. Power Plug w/Cord	3.50
PC311	L201516	PCB w/Comp, HEADPHONE JACK	3.85
PC398	L201517	PCB w/Comp, EXT SPKR JACK	1.75
PC410	L201518	PCB w/Comp, POWER SUPPLY	12.70
PC433	L201519	PCB w/Comp, LED CH DISPLAY	9.65
PC434	L201520	PCB w/Comp, CLOCK VOLTAGE REG.	5.00
PC435	L201521	PCB w/Comp, CH SELECT SW	9.30
PC443	L201522	PCB Only, CLOCK PUSH Sw Assy	1.50
PC455	L201523	PCB w/Comp, SLIDE Sw Assy	9.35
PC541	L201524	PCB w/Comp, LED CLOCK LOGIC	21.00
PC544	L201525	PCB w/Comp, MIC JACK	3.35
PC546	L201526	PCB w/Comp, TX/RX/CH 9 LED Ind	3.00
PC566	NSP	PCB w/Comp, MAIN	----
PL301	L201550	Pilot Lamp, RF PWR/SIG Meter	1.60
PL302	L201550	Pilot Lamp, SWR/MOD Meter	1.60
S301	L201530	Slide Sw, CH 9(AUTO)/CB Select	1.90
S302	L201530	Slide Sw, CB/PA Select	1.90
S303	L201530	Slide Sw, ANL On/Off	1.90
S304	L201530	Slide Sw, NB On/Off	1.90
S305	L201531	Slide Sw, MOD/CAL/SWR Select	2.15
S306	L201532	Slide Sw, AC/DC Select	2.15
S501	L103531	Rotary Sw, CHANNEL Select	9.90
SW181	L201533	Push Sw Assy, CLOCK CONTROL	11.95
S701	L201534	Push Sw, MANUAL POWER	2.60
S702	L201534	Push Sw, AUTO POWER	2.60
S703	L103532	Push Sw, AUTO POWER SET	3.30
S704	L103532	Push Sw, CLOCK SET	3.30
S705	L201536	Push Sw, FAST SCAN	3.00
S706	L201536	Push Sw, SLOW SCAN	3.00
S707	L201536	Push Sw, HOLD	3.00

REF. No.	CRAIG KEY No.	DESCRIPTION	MFR's SUGG RET. PRICE
MISCELLANEOUS ELECTRICAL (continued)			
SP301	L201702	Speaker 16 Ohm/3W	7.70
SW181	L201533	Push Sw Assy, (S701 S707)	11.95
VR1	L104590	Semi-Fixed Res. 500 Ohm	.65
VR2	L600593	Semi-Fixed Res. 50K Ohm	.70
VR3	L600593	Semi-Fixed Res. 50K Ohm	.70
VR4	L201590	Semi-Fixed Res. 30K Ohm	.70
VR5	L600593	Semi-Fixed Res. 50K Ohm	.70
VR6	S609590	Semi-Fixed Res. 5K Ohm	.70
VR201	L104590	Semi-Fixed Res. 500 Ohm	.65
VR301	L201570	VR 1K, RF GAIN Cont.	1.50
VR302	L201571	VR 50K, TONE Cont.	1.50
VR303	L201572	VR 50K, VOLUME Cont.	1.50
VR304	L201571	VR 50K, SQUELCH Cont.	1.50
VR305	L201573	VR 5K, SWR/CAL Cont.	1.50
VR306	L201574	VR 20K, DELTA TUNE Cont.	1.80
VR307	L201575	VR 5K, MIC GAIN Cont.	1.50
X1	L103722	Crystal, 10.240MHz	4.55
SEMICONDUCTORS			
D1, 2, 3, 7, 8, 13, 14, 15, 18, 19, 20, 22, 23, 25, 26, 27, 28, 29, 30, 33, 34, 702	1S2075K	Diode	.35
D5	1S2076A	Diode	.25
D6, 9, 10, 12, 32	1N60AM	Diode	.35
D16, 17	1S2688EA	Vari-Cap Diode	1.05

REF. No.	CRAIG KEY No.	DESCRIPTION	MFR's SUGG RET. PRICE
SEMICONDUCTORS (continued)			
D21	RD10EB1	Zener Diode	.40
D24, 31	1N4003	Diode	.65
D201, 202, 203, 204	GM-3Y	Diode	1.50
D205	RD16FB	Zener Diode	1.05
D206	RD7.5EB2	Zener Diode	.40
D301, 303	TLR124	LED, TX/CH 9 Indicator	.85
D302	TLG124A	LED, RX Indicator	1.35
D501	UR202	LED, CHANNEL Indicator	9.15
D701	TLR2077	LED, CLOCK DIGITAL DISPLAY	13.30
D801	CZ092	Zener Diode	1.00
IC1	TC9106P	I.C. (PLL)	10.60
IC2	TA7310P	I.C. (TX MIX)	1.75
IC3	TA7222P	I.C. (AF POWER AMP)	5.65
IC701	TM4801P	I.C. (CLOCK LOGIC)	11.70
TR1, 11, 12, 13, 203, 701	2SC711	Transistor	.95
TR2	2SC1674	Transistor	1.50
TR3	2SK19	FET	4.40
TR4, 5, 6, 7, 10, 16, 22, 23, 24, 26	2SC710	Transistor	1.15
TR8	2SC2029	Transistor	2.90
TR9	2SC2028	Transistor	1.65
TR14, 15, 19	2SC458	Transistor	1.85
TR17, 20, 25	2SA628	Transistor	.45
TR18, 21	2SD355	Transistor	1.50
TR201	2SD586	Transistor	3.80
TR202, 801	2SC1096	Transistor	3.40

WIRING DIAGRAM "A"

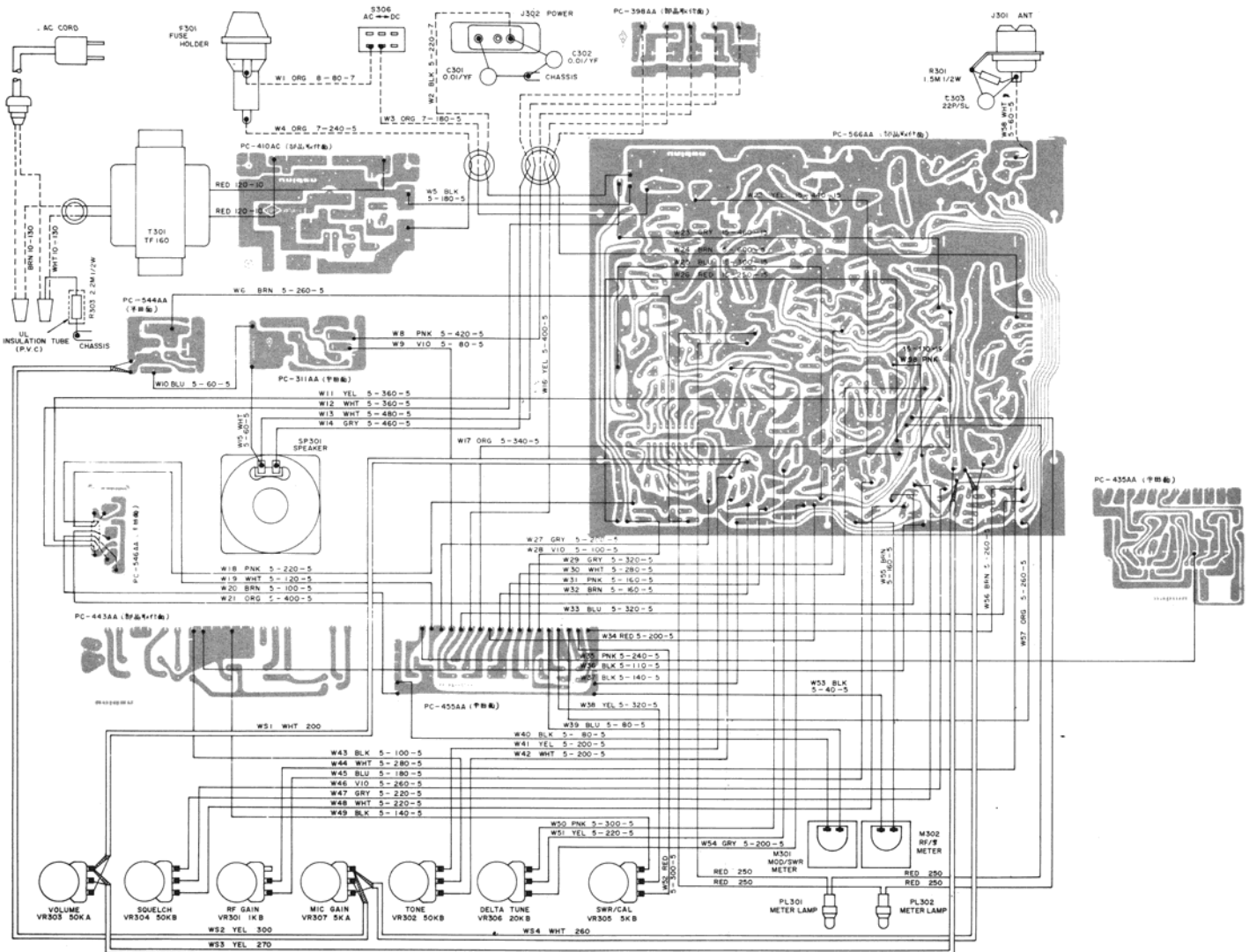

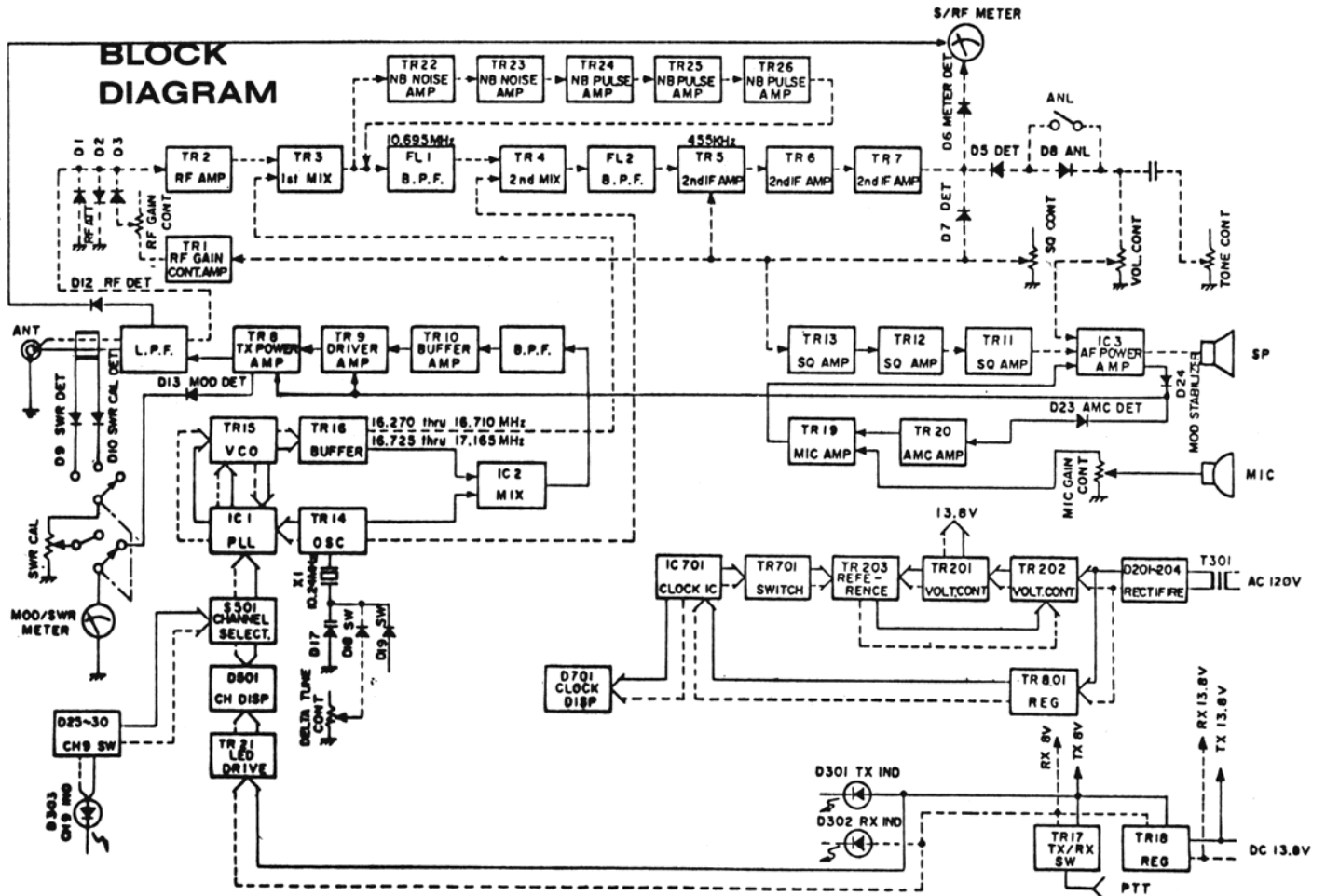

WIRING DIAGRAM "B"

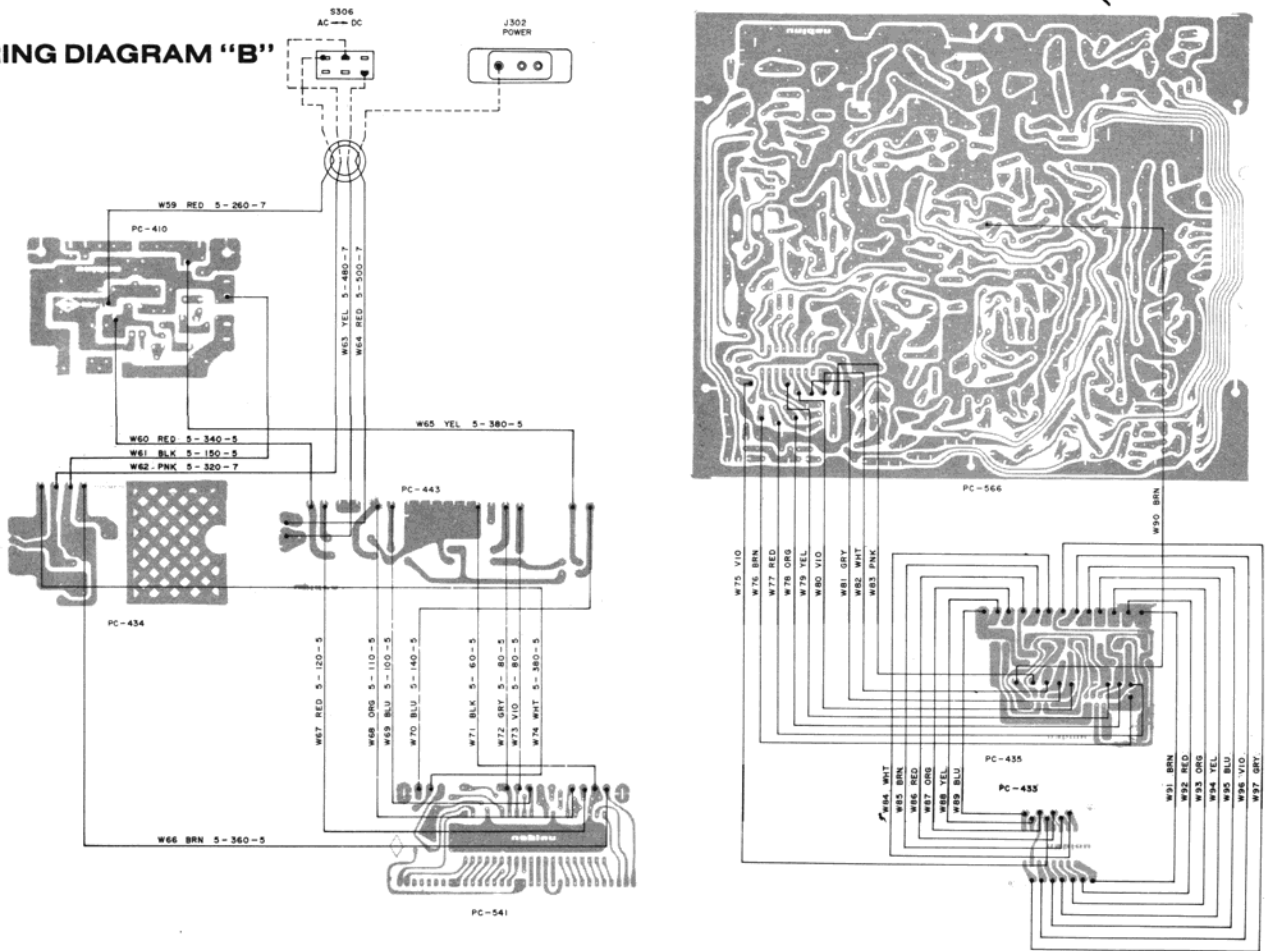

TRANSISTOR VOLTAGE CHART

	(RX)			(TX)				(RX)			(TX)		
	E	B	C	E	B	C		E	B	C	E	B	C
TR1 (SQ) (UNSQ)	0 0	.63 .63	.11 .09	0	.54	1.20	TR15	3.00	3.60	6.34	2.98	3.60	6.31
TR2 (SQ) (UNSQ)	1.29 1.38	.54 .63	9.38 9.36	.42	0	.24	TR16	0	.61	2.36	0	.25	2.35
TR3 FET	2.44 (SOURCE)	0 (GATE)	7.39 (DRAIN)	2.44 (SOURCE)	0 (GATE)	7.34 (DRAIN)	TR17	8.70	9.26	.06	8.66	7.85	8.54
TR4 (SQ) (UNSQ)	.89 .96	1.26 1.35	7.41 7.29	.02	.39	.12	TR18	8.79	9.40	13.45	8.74	9.39	12.78
TR5 (SQ) (UNSQ)	.65 .74	1.21 1.32	8.92 8.85	0	.42	.24	TR19	9.47	1.69	8.46	.84	1.49	5.66
TR6	0	.68	1.59	0	0	.24	TR20	0	0	0	0	0	0
TR7	.91	1.59	13.54	0	.24	13.76	TR21	6.59	7.22	12.20	6.54	7.17	12.05
TR8	0	0	13.51	0	0	13.48	TR22	0	0	0	0	0	0
TR9	0	0	13.32	0	-.01	13.30	TR23	0	0	0	0	0	0
TR10	9.49	2.35	13.78	.85	1.20	12.95	TR24	0	0	0	0	0	0
TR11(SQ) (UNSQ)	0 0	.64 0	0 0	0	.64	0	TR201	13.84	14.50	0	13.85	14.51	0
TR12(SQ) (UNSQ)	0 0	.04 .65	4.73 0	0	.24	4.70	TR202	14.50	15.05	0	14.51	15.07	0
TR13(SQ) (UNSQ)	0 0	.61 .57	.04 .65	0	.22	.24	TR203	7.24	7.83	15.05	7.24	7.83	15.07
TR14	2.11	2.61	7.51	2.09	2.59	7.46	TR701	0	.66	0	0	.66	0
							TR801	8.57	9.17	0	8.55	9.15	0

VOLTAGE CHART (IC701)

PIN #	Voltages measured FROM TO		PIN #	Voltages measured FROM TO	
	FROM	TO		FROM	TO
1	.78	.81	22	.26	.28
2	.28	.30	23	.26	.28
3	.78	.80	24	0	0
4	.28	.30	25	8.45	8.45
5	.27	.29	26	.65	.65
6	.27	.29	27	0	0
7	.26	.28	28	-.03	-.03
8	.86	.90	29	.39	.39
9	.27	.29	30	0	0
10	.26	.28	31	8.56	8.56
11	.79	.81	32	8.15	8.15
12	.27	.29	33	8.13	8.13
13	.27	.29	34	8.24	8.24
14	.26	.28	35	8.53	8.53
15	.26	.28	36	8.52	8.52
16	.27	.29	37	0	0
17	.78	.80	38	5.21	5.21
18	.27	.29	39	8.51	8.51
19	.26	.28	40	0	0
20	0	0	41	.27	.29
21	0	0	42	.27	.29

NOTE: All of the voltages measured on IC701 were made with the clock's readout showing 12:00 P.M.. As the readout changes to read 12:01p.m., adjust the CLOCK SET switch for a reading of 12:00 P.M. again.

Also note that most voltages measured will vary from $\pm .02$ to $\pm .04$ volts. The voltage chart has been adapted for this. Example; Pin #1 on the chart reads; "FROM .78 Vdc TO .81 Vdc". This informs you that the voltage measured on this pin of the I.C. will vary between these two voltages.

NOTES:

Voltages measured on CHANNEL 9 @ NO MODULATION.

CONTROL or SWITCH	SET TO:
RF GAIN (VR301);	MINIMUM
tone (VR302);	MECHANICAL CENTER
SWR/CAL (VR305);	MINIMUM
CB/P.A. (S-302);	CB Position
NB On/Off (S-304);	OFF Position
AC/DC (S-306);	AC Position
AUTO (POWER) (S-702);	OFF Position
CLOCK (SET) (S-704);	ON Position

CONTROL or SWITCH	SET TO:
MIC GAIN (VR307);	MINIMUM
DELTA TUNE (VR306);	MECHANICAL CENTER
DIAL/CH. 9 (S-301);	DIAL Position
ANL On/Off (S-303);	OFF Position
MOD/CAL/SWR (S-305);	CAL Position
MANUAL (POWER) (S-701);	ON Position
AUTO PWR (SET) (S-703);	OFF Position

CLOCK/LOGIC SCHEMATIC DIAGRAM

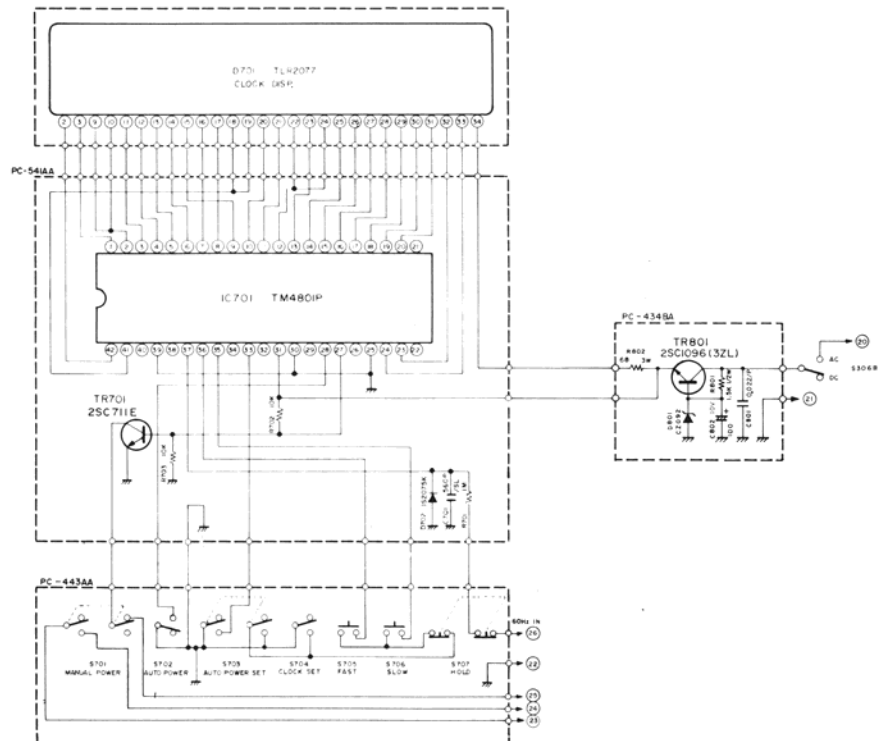

MAIN PCB

PC-566A

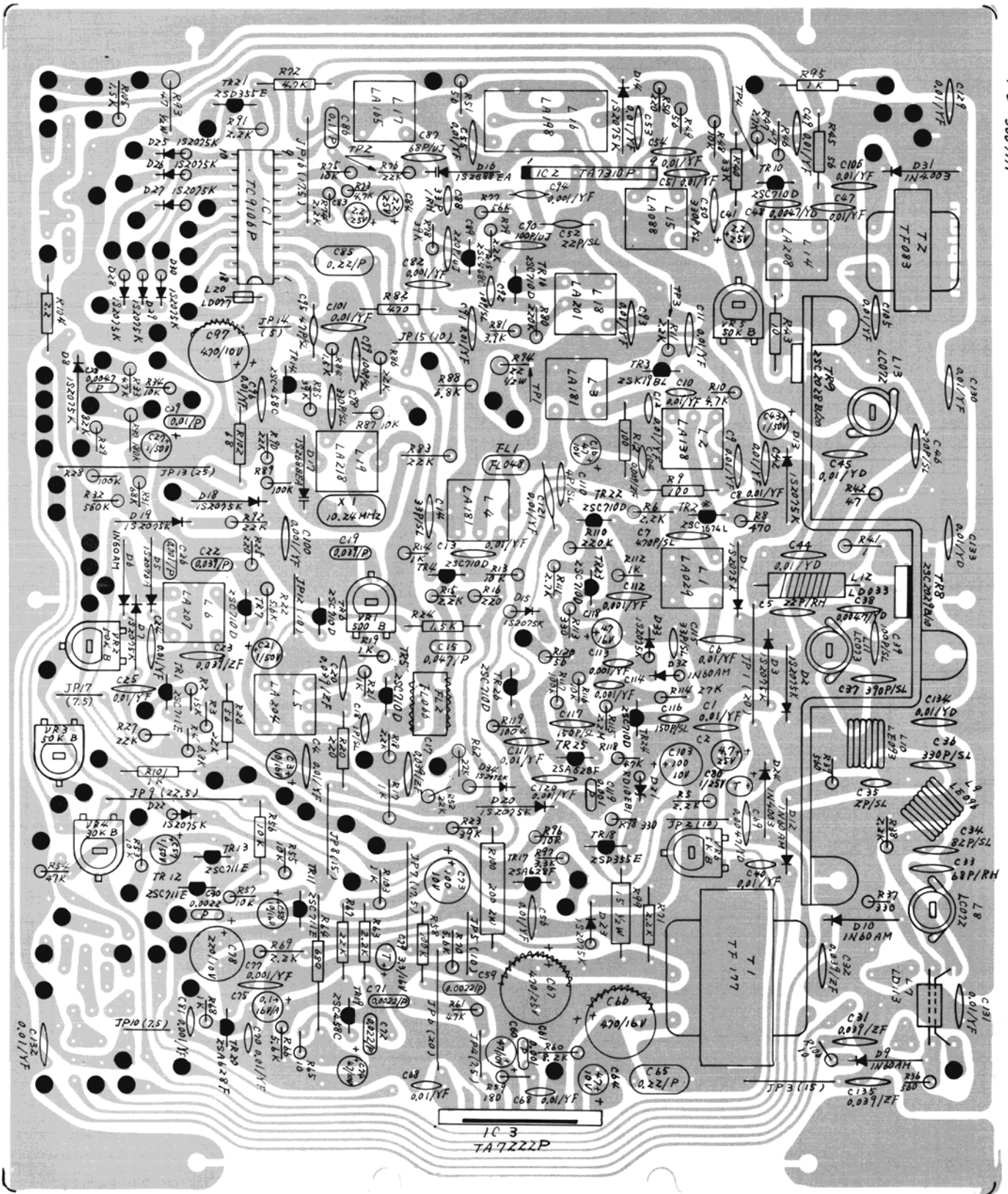

CABINET & CHASSIS

