

Mixers

S 042 P

Bipolar IC

Features

- Versatile application
- Wide range of supply voltage
- Few external components
- High conversion transconductance
- Low noise figure

Type	Ordering Code	Package
S 042 P	Q67000-A335	P-DIP-14

Symmetrical mixer for frequencies up to 200 MHz. It can be driven by an external source or by the built-in oscillator. The input signals are suppressed at the outputs. In addition to the usual mixer applications in receivers, converters, and demodulators for AM and FM, the S 042 P can also be used as electronic polarity switch, multiplier etc.

Absolute Maximum Ratings

Parameter	Symbol	Limit Values	Unit
Supply voltage	V_S	15	V
Junction temperature	T_j	150	° C
Storage temperature range	T_{stg}	- 40 to 125	° C
Thermal resistance (system-air)	$R_{th SA}$	90	K/W

Operating Range

Supply voltage	V_S	4 to 15	V
Ambient temperature	T_A	-15 to 70	° C

Characteristics

$V_S = 12\text{ V}$, $T_A = 25\text{ }^\circ\text{C}$

Parameter	Symbol	Limit Values			Unit
		min.	typ.	max.	
Current consumption	$I_S = I_2 + I_3 + I_5$	1.4	2.15	2.9	mA
Output current	$I_2 = I_3$	0.36	0.52	0.68	mA
Output current difference	$I_3 - I_2$	-60		60	μA
Supply current	I_5	0.7	1.1	1.6	mA
Power gain $f_i = 100\text{ MHz}$, $f_{osc} = 110.7\text{ MHz}$	G_P	14	16.5		dB
Breakdown voltage $I_{2,3} = 10\text{ mA}$; $V_{7,8} = 0\text{ V}$	V_2, V_3	25			V
Output capacitance	C_{2-M}, C_{3-M}		6		pF
Conversion transconductance $f = 455\text{ kHz}$	$S = \frac{I_2}{V_7 - V_8} = \frac{I_3}{V_7 - V_8}$		5		mS
Noise figure	NF		7		dB

Test Circuit

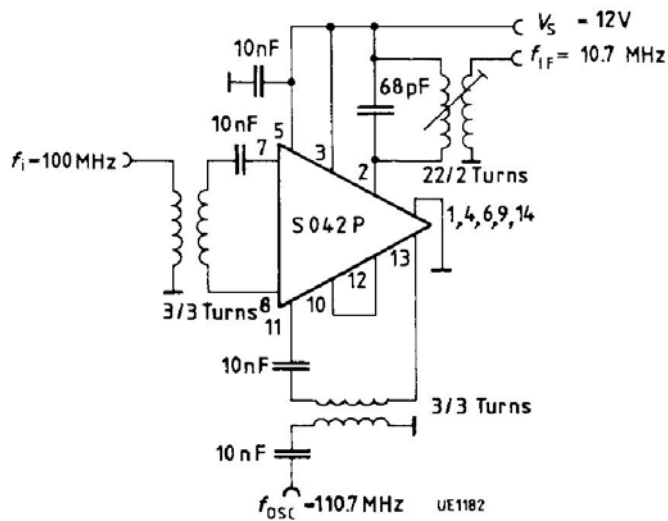

Circuit Diagram

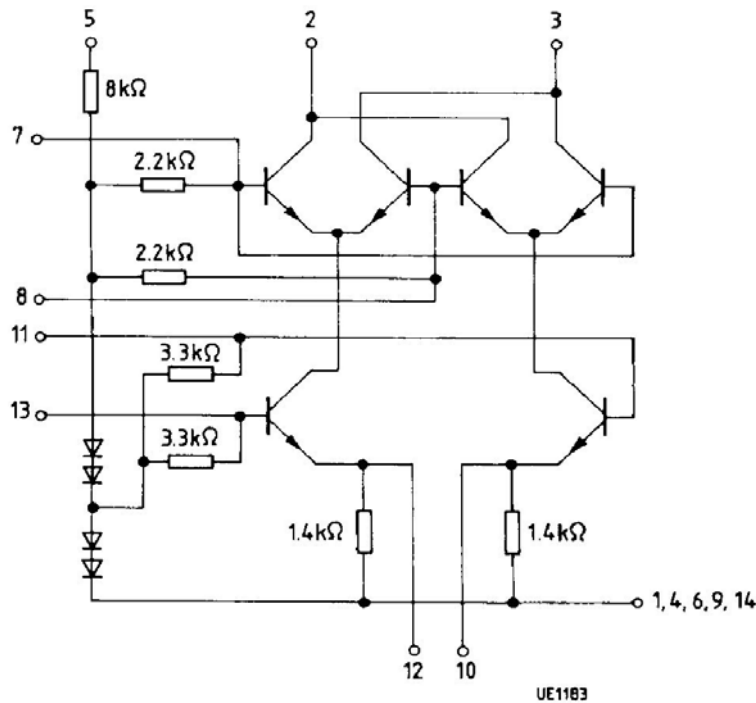

A galvanic connection between pins 7 and 8 and pins 11 and 13 through coupling windings is recommended.

A resistor of at least $220\ \Omega$ may be connected between pins 10 and 14 (ground) and between pins 12 and 14 to increase the currents and thus the conversion transconductance. Pins 10 and 12 may be connected through any impedance. In case of a direct connection between pins 10 and 12, the resistance from this pin to 14 may be at least $100\ \Omega$. Depending on the layout, a capacitor (10 to $50\ \text{pF}$) may be required between pins 7 and 8 to prevent oscillations in the VHF band.

Total current consumption versus supply voltage

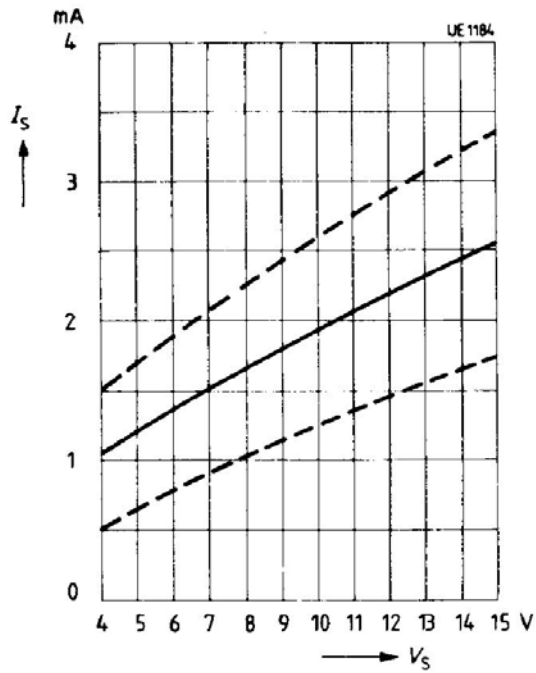

Output current versus supply voltage

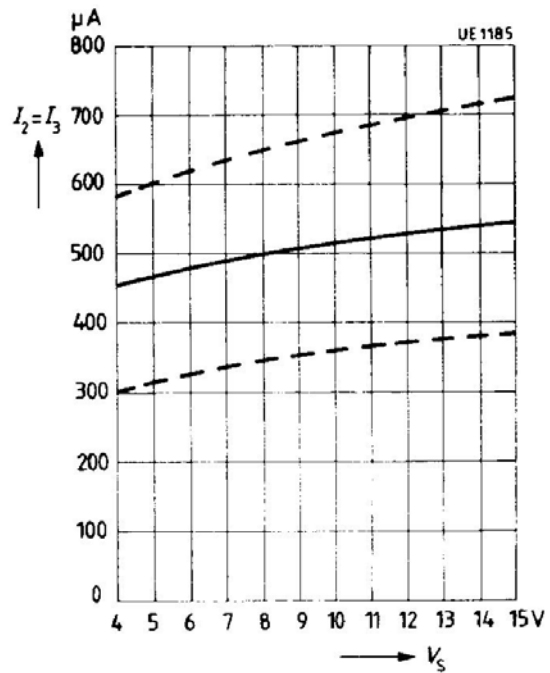

Power gain versus supply voltage

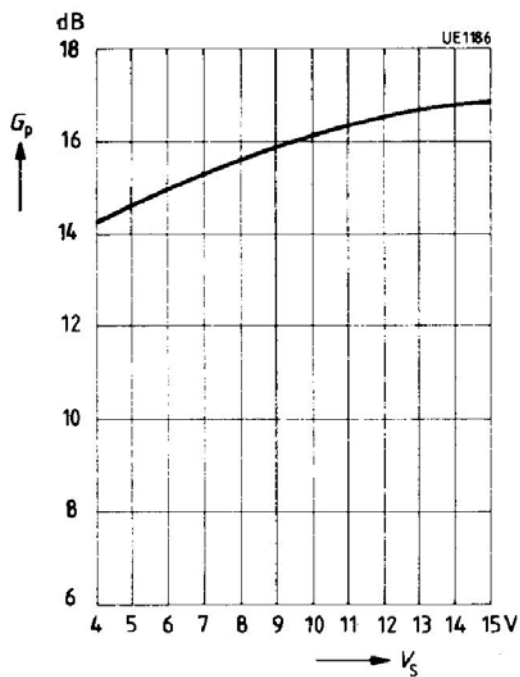

Application Circuits

FM Mixer with inductive tuning

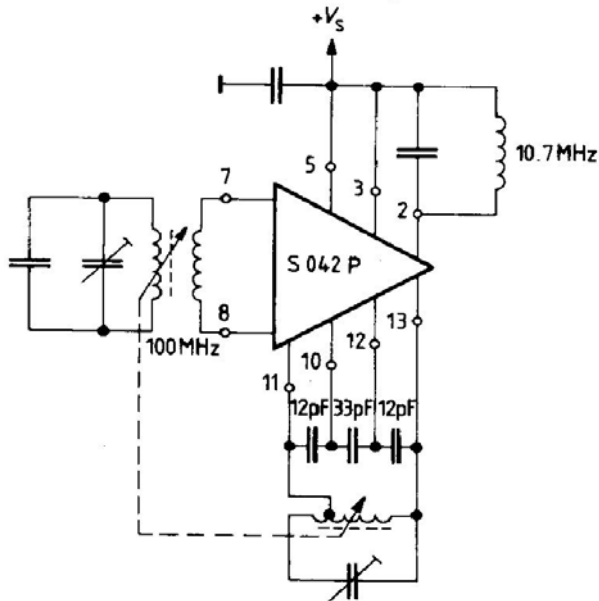

FM Mixer with crystal oscillator

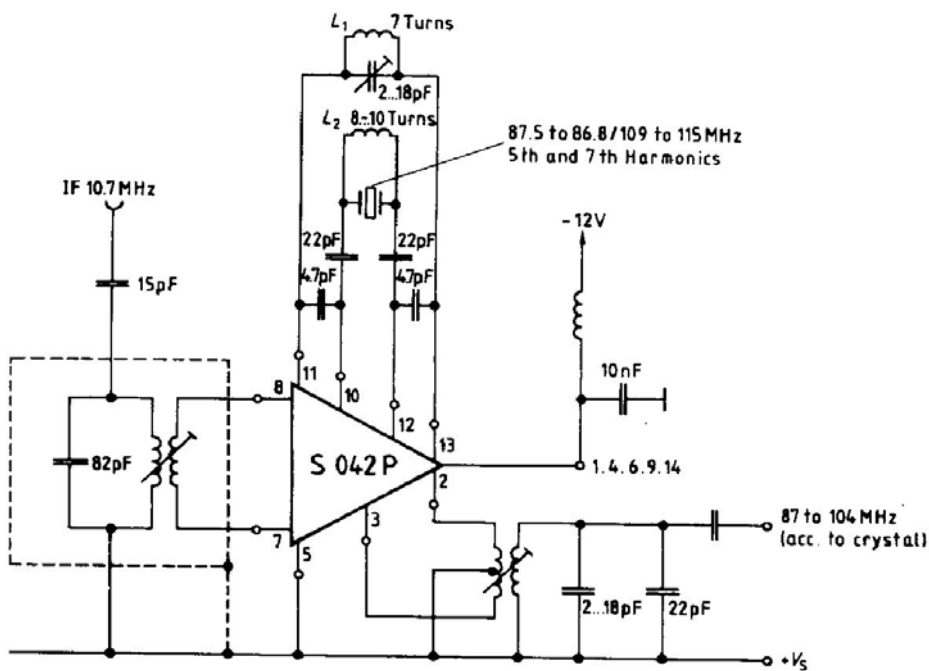

For harmonic crystals an adequate inductance is recommended between pins 10 and 12 to avoid oscillations to the fundamental.

Mixer for Short-Wave Application
in self-oscillating operation

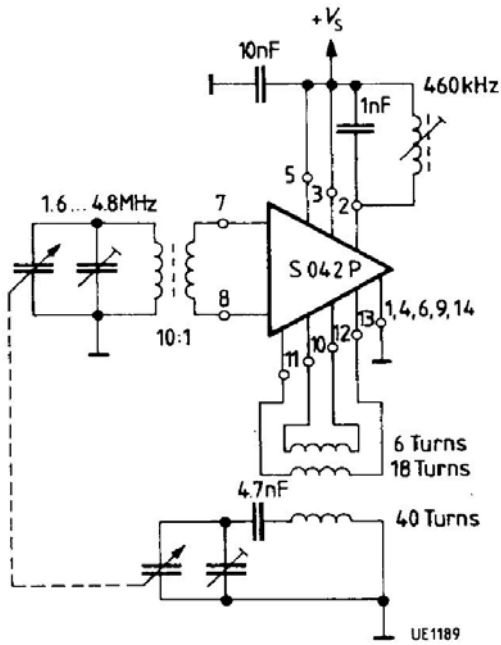

Differential Amplifier with internal neutralization, also suited for use as limiter for frequencies up to 50 MHz or at higher currents up to 100 MHz

