

This Manual is provided by
CBTricks.com

Someone who wanted to help you repair your equipment
scanned this manual.

If you would like to help us put more manuals online support us.

Supporters of CBTricks.com paid for the hosting so you would have this file.

CBTricks.com is a non-commercial personal website was created to help promote the exchange of service, modification, technically oriented information, and historical information aimed at the Citizens Band, GMRS (CB "A" Band), MURS, Amateur Radios and RF Amps.

CBTricks.com is not sponsored by or connected to any Retailer, Radio, Antenna Manufacturer or Amp Manufacturer, or affiliated with any site links shown in the links database. The use of product or company names on my web site is not endorsement of that product or company.

If your company would like to provide technical information to be featured on this site I will put up on the site as long as I can do it in a non-commercial way.

The site is supported with donation from users, friends and selling of the Galaxy Service Manual CD to cover some of the costs of having this website on the Internet instead of relying on banner ads, pop-up ads, commercial links, etc. to pay my costs. Thus I do not accept advertising banners or pop-up/pop-under advertising or other marketing/sales links or gimmicks on my website.

ALL the money from donations is used for CBTricks.com I didn't do all the work to make money (I have a day job).
This work was not done for someone else to make money also, for example the ebay CD sellers.

All Trademarks, Logos, and Brand Names are the property of their respective owners.
This information is not provided by, or affiliated in any way with any radio or antenna Manufacturers.

Thank you for any support you can give.

INTRODUCTION

Your new model 13-870C is a combination receiver-transmitter designed and engineered for licensed class "D" operation on any of the 23 channels designated as Citizens Band frequencies by the Federal Communication Commission. You are required to read and understand Part 95 of the F.C.C. regulations prior to operations of this unit. Copies of part 95, covering regulations for Citizens Band Radio Service, are available by writing to the Superintendent of Documents, U. S. Government Printing Office, Washington 25, D.C. You are required to complete F. C. C. form 505 and submit it to the Federal Communications Commission in order to receive your license to operate this unit. Part 95 of the F. C. C. regulations will be violated if you operate this transceiver on the air prior to receipt of your license and call sign.

UNDERSTANDING YOUR NEW 13-870C

RECEIVER:

Sensitive dual conversion circuit with all crystals supplied for 23-channel reception. One microvolt sensitivity, built-in controlled squelch circuit and noise limiting give noise-free operation. Active AGC circuit eliminate fading and over driving.

TRANSMITTER:

Precision crystal-controlled oscillator circuit with all 23 Citizens Band channels built in. A full 5-watts RF input power is effectively converted into radiated output power with a minimum of loss for a stronger signal. A maximum of TVI filtering is employed. Pi-network matching for exact loading to any standard CB antenna.

"S"- "RFO" METER:

A combination meter on front panel provides a constant visual monitor of incoming "Signal Strength" When receiving and "Relative Output Power" when transmitting.

CONTROLS:

A full set of controls is employed, including volume push-on switch, 23-channel selector switch, full variable squelch, public address switch and call signal switch.

PUBLIC ADDRESS SWITCH:

In the "PA" position, your transceiver is converted to a public address system. A convenient pin jack on the back panel is provided for connection to any standard 8 ohm PA speaker.

POWER SUPPLY:

The 13-870C is designed to operate on 12 volts DC. Any 12-volt (negative ground) automobile system is adequate. For base station application, use Midland 18-805 (optional extra) power supply which plugs into 110 volts AC and delivers 12 volts DC to your transceiver.

ANTENNA REQUIREMENT:

This transceiver will operate with any standard 52 ohm ground-plane, vertical, mobile whip, long wire or other CB antenna. A standard SO 239 type connector is provided on the back panel for use with popular PL 259 antenna plug. An adjustable loading network is provided to match antenna impedance exactly.

FREQUENCY:

Each unit is completely equipped with crystals for operation on any of the 23 Citizens Band channels. It is not necessary to purchase any additional crystals for this unit. Refer to part 95 of the F. C. C. rules and regulations to determine which channels may be used for various kinds of communication.

MOBILE INSTALLATIONS

A location in the car or truck should be chosen carefully for convenience of operation and non-interference with normal driving functions. Mounting may be under the dash or instrument panel or any place a secure installation can be made. The carrying handle again serves as the mounting bracket or additional perforated straps or brackets may be used as desired. The 12-volt cable may be connected to any convenient terminal but preferably to the ignition switch to prevent unauthorized persons from operation of your unit. With this method the unit will only operate when your key is turned on. Engine ignition interference should not be a problem and vehicles equipped with standard broadcast radios will have enough suppression to eliminate ignition interference. If ignition interference is present, any skilled auto radio repairman should be able to eliminate it for you. A 1.0 mfd condenser connected between the generator armature post and ground will help greatly.

BASE STATION INSTALLATIONS

For base station use, the Midland model 18-805 power supply is recommended. When this power supply is used, simply connect the red (+) and black (-) terminals on the power supply to the (+) and (-) leads on your 13-870C. Do not attempt to operate this transceiver by connecting directly to 110 Volts AC.

ANTENNA INSTALLATION

BASE STATION:

When the 13-870C is used as a base station, any Citizens Band beam, dipole, ground plane or vertical antenna may be used. A ground plane type will provide greater coverage and, since it is essentially non-directional, it is ideal in base station to mobile operation. From base station to base station, or point to point operation, a directional beam will give greater distance even under adverse condition. The range of the transceiver depends basically on the height of the antenna and, whenever possible, select the highest location within F.C.C. limits. (These regulations limit the antenna height to 20 feet above an existing structure). Generally a maximum of 26 feet of lead-in cable should be used due to line losses. However, a desirable antenna location may justify the loss in extra lead-in length.

MOBILE ANTENNAS:

A vertical whip antenna is best suited for mobile use. A non-directional antenna must be used for best results in any case. The base loaded whip antenna will normally provide effective communication. For greater range and more reliable operation, a full quarter-wave whip should be used. Either of these antennas use the metal car body as a ground plane and the shield of the base lead as well as the metal case of the transceiver should be grounded. A standard antenna connector (type SO 239) is provided on the transceiver for easy connection to a standard PL 259 cable termination.

OPERATION OF CONTROLS

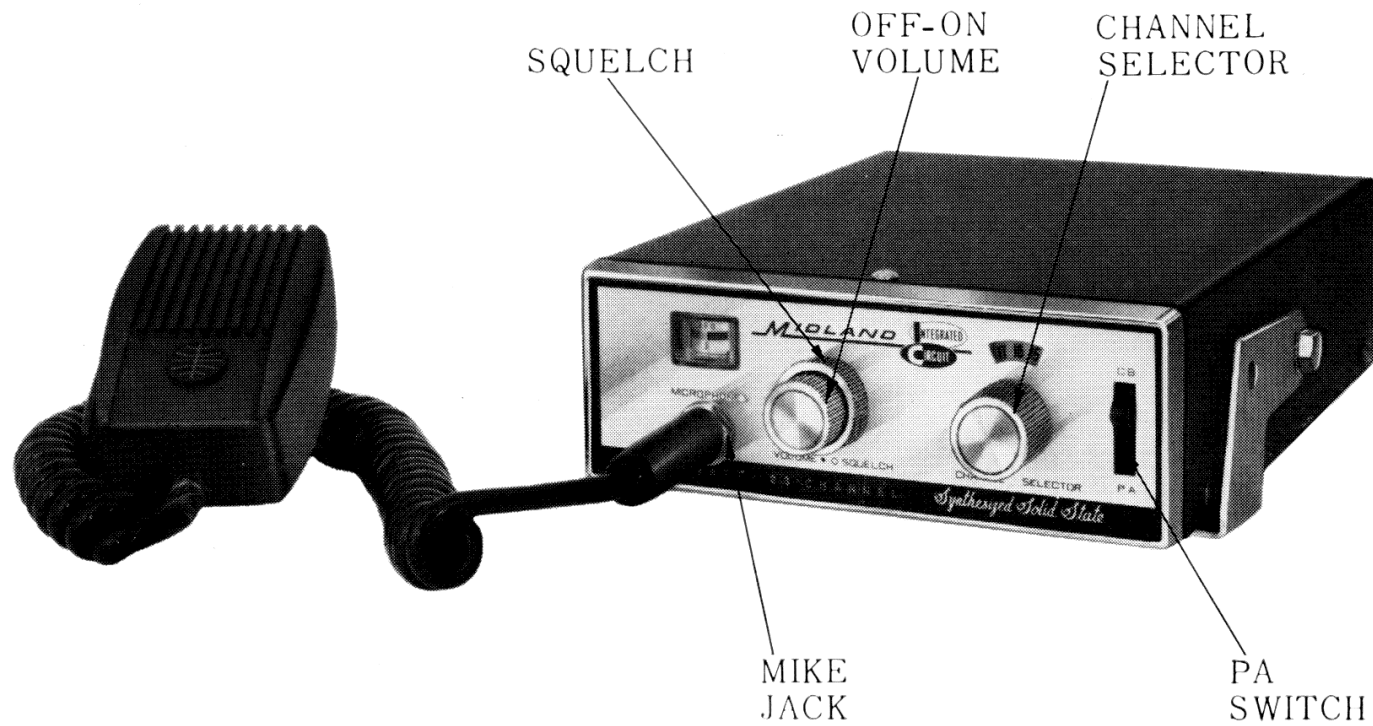

VOLUME CONTROL AND OFF-ON SWITCH:

The volume control varies the sound output of the loudspeaker. It also functions as a push button "off-on" switch. Press in this control to turn the power on; press in again to turn power off. Clockwise rotation increases volume.

CHANNEL SELECTOR SWITCH:

Tuning the receiver and transmitter is simultaneous by rotating the 23 channel selector switch. Set switch to desired channel, 1 to 23, as indicated directly above switch knob.

SQUELCH CONTROL:

The squelch control is designed to reduce excessive noise (such as high line interference, ignition noise, etc.) This control must be set when only noise, no signal is heard. Turn the control fully clockwise and increase the volume until noise or a signal is heard. When only noise is present, turn the squelch control counterclockwise until the noise is blanked out.

PUBLIC ADDRESS SWITCH:

In the "PA" position, your transceiver is converted to a public address system. A convenient pin jack on the back panel is provided for connection to any standard 8 ohm PA speaker.

PRESS-TO-TALK MICROPHONE:

The receiver and transmitter are controlled by the press-to-talk switch on the microphone. Press in this switch and the transmitter is activated. Release this switch to receive. When transmitting, hold microphone 3 to 4 inches from mouth and speak clearly and in a normal voice.

GENERAL OPERATING INSTRUCTIONS

CAUTION:

Before operating this transceiver, you are required by law to read and thoroughly understand Part 95 of the F. C. C. rules and regulations.

Check to see if the proper connections have been made on power cable, antenna system and microphone and that the correct cables have been used. Be sure that the transceiver is adequately grounded (if not mounted directly to a metal surface).

To transmit, press the push-to-talk switch and hold it down. Speak directly into the microphone. Release this switch to receive. Actual receive and transmitting power should be monitored by watching the RFO meter and

using the switch provided for this purpose.

Select the channel on which you wish to operate by rotating the Channel Selector Switch to the desired channel.

The microphone should be held approximately 3 to 4 inches away from your mouth. Use a normal speaking voice. Speak slowly and clearly. Talking louder does not increase transmitting power and only causes distortion. You will notice the RFO meter moving as you transmit. This indicates that you are transmitting. Always release the microphone switch when you complete your transmission.

For best receiving results, observe the "S" meter.

SERVICING YOUR TRANSCEIVER

The technical information, diagrams and charts provided in this manual are supplied for the use of a qualified holder of a first or second class radiotelephone license in servicing this transceiver. It is the users responsibility to see that this unit is operating at all times in accordance with the F. C. C. citizens radio service regulations.





If you install your own transceiver, do not attempt to make any transmitter tuning adjustments. Adjustments are prohibited by the F.C.C. unless you hold or are in the presence and under the supervision of a first or second class radiotelephone licensed person. A Citizens Band or Amateur license is not sufficient.

ANTENNA LOADING ADJUSTMENT

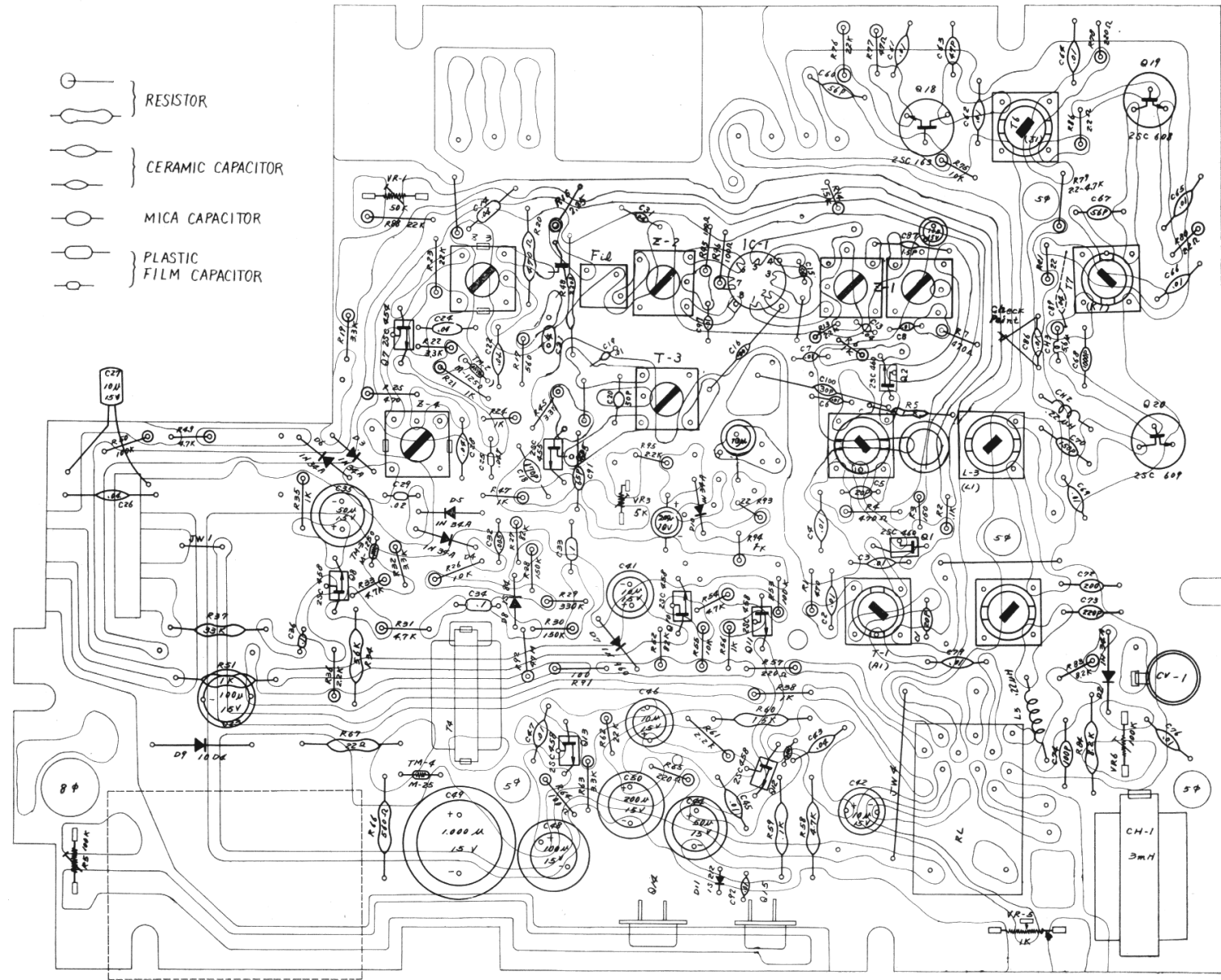
In order to insure maximum power transfer to the antenna, a loading adjustment is provided. For best results, disconnect the antenna and connect a number 47 lamp to the antenna receptacle. The center terminal of the lamp should make contact with the center jack of the receptacle and the outer shell of the lamp should be connected to ground. With an alignment tool, adjust the antenna load coil for maximum reading on the RFO meter and maximum brilliance of the lamp. Readjust antenna output for maximum reading and lamp brilliance.

MODEL 13-870C PARTS LAYOUT



-  } RESISTOR
-  } CERAMIC CAPACITOR
-  } MICA CAPACITOR
-  } PLASTIC FILM CAPACITOR

SYNTHESIZED SYSTEM
PRINTED CIRCUIT BOARD

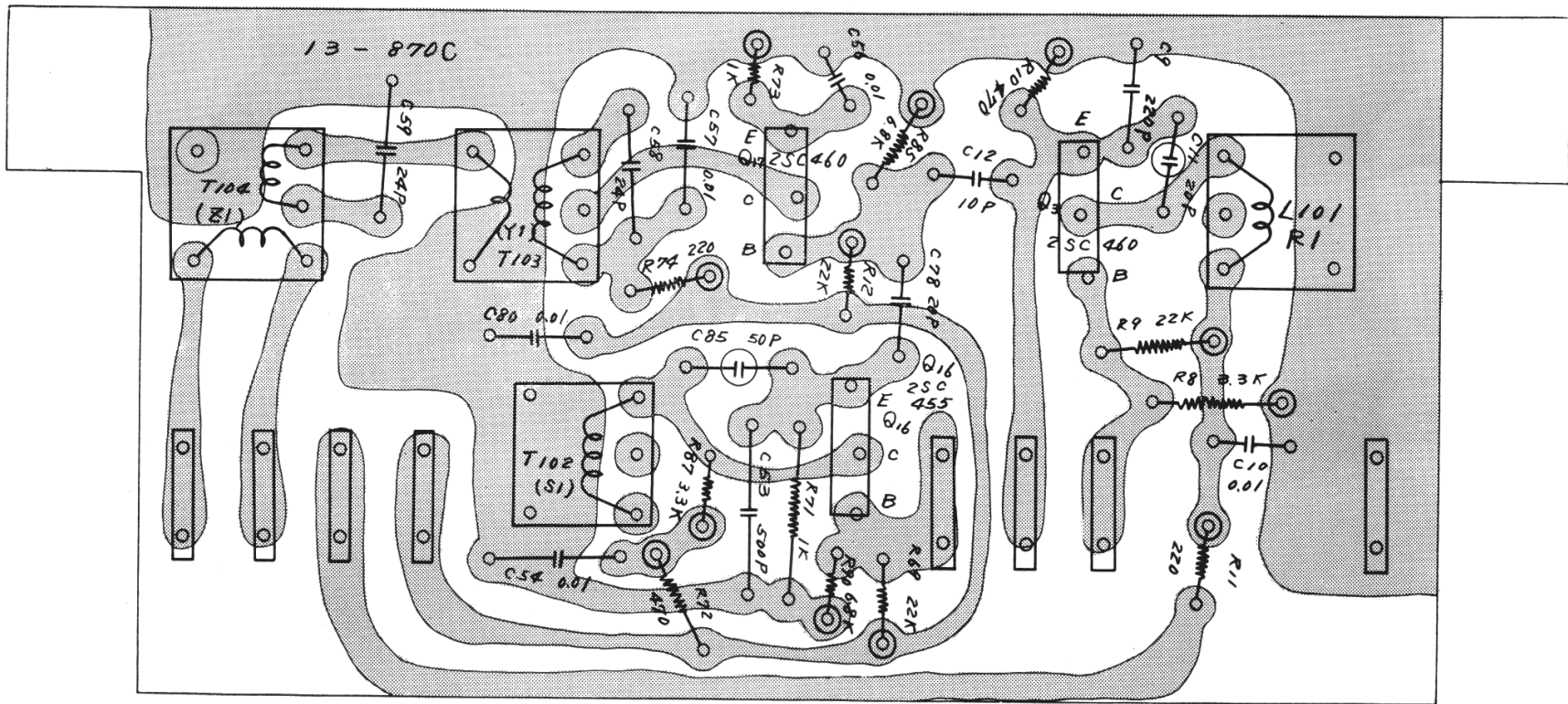

MODEL 13-870C SCHEMATIC DIAGRAM

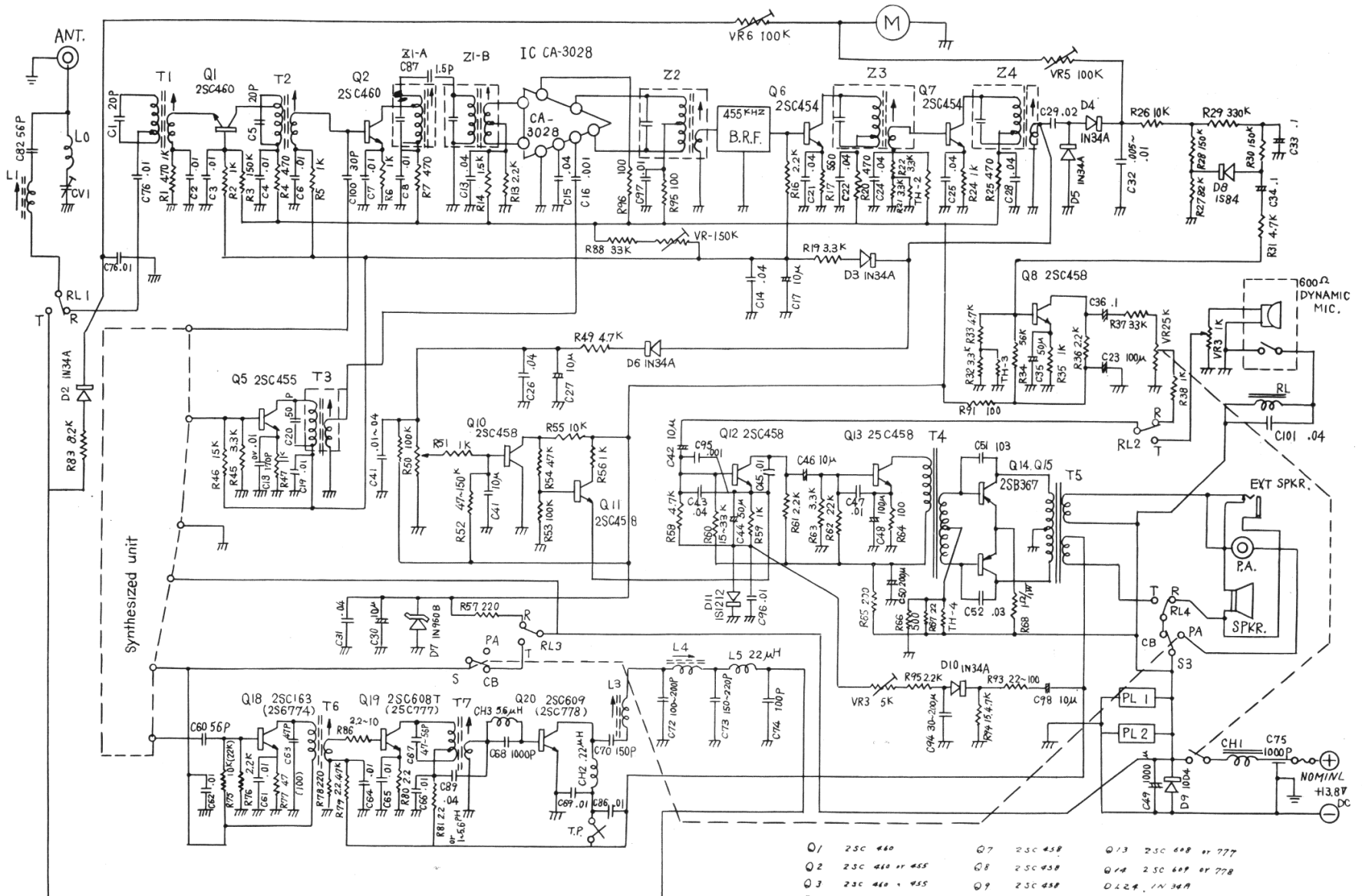

- | | | | | | |
|----|----------------|-----|----------------|----------|----------------|
| Q1 | 2SC 460 | Q7 | 2SC 458 | Q13 | 2SC 608 or 777 |
| Q2 | 2SC 460 or 455 | Q8 | 2SC 458 | Q14 | 2SC 609 or 778 |
| Q3 | 2SC 460 or 455 | Q9 | 2SC 458 | D1, 2, 3 | 1N 34A |
| Q4 | 2SC 458 | Q10 | 2SB 367 | D3 | 1.5 BA |
| Q5 | 2SC 458 | Q11 | 2SB 367 | TH-1 | M-25 or D-19 |
| Q6 | 2SC 458 | Q12 | 2SC 150 or 774 | TH-1 | M-1050 |

MIDLAND INTERNATIONAL CORPORATION CERTIFIES THAT THIS EQUIPMENT HAS BEEN DESIGNED, MANUFACTURED AND FURNISHED IN ACCORDANCE WITH THE SPECIFICATIONS CONTAINED IN PART 95 OF THE F.C.C. RULES AND REGULATIONS AS EFFECTIVE MARCH 1966.

WARRANTY POLICY

Midland International Corporation warrants each new Midland product to be free from defects in material and workmanship under normal use and service for a period of 90 days after delivery to the ultimate user and will replace or repair the product, at our option, at no charge should it become defective and which our examination shall disclose to be defective and under warranty.

This warranty shall not apply to any Midland product which has been subject to misuse, neglect, accident, incorrect wiring not of our own installation, or to use in violation of instructions furnished by us, nor extended to units which have been repaired or altered outside of our factory.

This warranty does not cover carrying cases, earphones, batteries, antennas, broken or cracked cabinets, or any other accessory used in connection with the product.

This warranty is in lieu of all other warranties expressed or implied and no representative or person is authorized to assume for us any other liability in connection with the sale of our products.

Sales receipt must accompany product to validate date of purchase.

MIDLAND INTERNATIONAL CORPORATION

1909 Vernon Street

North Kansas City, Missouri 64116

PRINTED IN JAPAN