

**This Manual is provided by**  
**CBTricks.com**

Someone who wanted to help you repair your equipment  
scanned this manual.

If you would like to help us put more manuals online support us.

Supporters of CBTricks.com paid for the hosting so you would have this file.

CBTricks.com is a non-commercial personal website was created to help promote the exchange of service, modification, technically oriented information, and historical information aimed at the Citizens Band, GMRS (CB "A" Band), MURS, Amateur Radios and RF Amps.

CBTricks.com is not sponsored by or connected to any Retailer, Radio, Antenna Manufacturer or Amp Manufacturer, or affiliated with any site links shown in the links database. The use of product or company names on my web site is not endorsement of that product or company.

If your company would like to provide technical information to be featured on this site I will put up on the site as long as I can do it in a non-commercial way.

The site is supported with donation from users, friends and selling of the Galaxy Service Manual CD to cover some of the costs of having this website on the Internet instead of relying on banner ads, pop-up ads, commercial links, etc. to pay my costs. Thus I do not accept advertising banners or pop-up/pop-under advertising or other marketing/sales links or gimmicks on my website.

ALL the money from donations is used for CBTricks.com I didn't do all the work to make money (I have a day job). This work was not done for someone else to make money also, for example the ebay CD sellers.

All Trademarks, Logos, and Brand Names are the property of their respective owners.  
This information is not provided by, or affiliated in any way with any radio or antenna Manufacturers.  
Thank you for any support you can give.

# REALISTIC

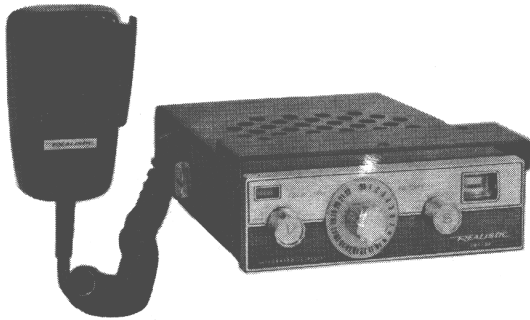

## 23 CRYSTAL-CONTROLLED CHANNELS

### SOLID STATE WITH INTEGRATED CIRCUIT

## MODEL TRC-24

## CATALOG NO. 21-124

# SERVICE MANUAL

## SPECIFICATIONS

### RECEIVER

SENSITIVITY.....0.5 $\mu$ V for 10 dB S+N/N  
SELECTIVITY.....35 dB $\pm$ 8KHz  
SQUELCH.....Adjustable  
IF FREQUENCY.....10.62MHz- 455KHz  
AUDIO OUTPUT..... 3 watts

### TRANSMITTER

POWER INPUT..... 5 watts  
POWER OUTPUT.....2.5 watts min.  
MODULATION.....100%-90%  
RF FREQUENCY STABILITY...0.005%

### TRANSISTOR COMPLEMENT

Q 1 2SC535 .....RF Amp. (Rec.)  
Q 2 2SC460 .....First Mixer (Rec.)  
Q 3 2SC460 .....Second Mixer (Rec.)  
Q 4 2SC454 .....First IF Amp.  
Q 5 2SC454 .....Second IF Amp.  
Q 6 2SC460 .....Transmit/Rec. Oscillator  
Q 7 2SC460 .....Receiver Oscillator  
Q 8 2SB337.....Audio Power  
Output/Modulator

Q 9 2SB337.....Audio Power  
Output/Modulator  
Q10 2SC460.....Transmitter Oscillator  
Q11 2SC717.....Transmitter Mixer  
Q12 2SC150T .....Transmit Buffer  
Q13 2SC116T .....Transmit RF Driver  
Q14 2SC609T .....Transmit RF Power Output  
Q15 2SC458 .....Audio Amplifier

### IC'S

IC 1 FA6007T.....Squelch Amp.  
IC 2 FA6007T.....Audio/Speech Amplifier

### DIODES

D 1 1N60.....RF Overload Protector  
D 2 1N60 .....Detector  
D 3 1N60.....Automatic Noise Limiter  
D 4 1N34A .....Switching  
D 5 TR-9S.....Voltage Regulator  
D 6 HR-5A.....Reverse Polarity Protector

GENERAL POWER } 12-14V DC Negative  
REQUIREMENT } Ground

MAX. POWER CONSUMPTION...17 watts

MICROPHONE.....Ceramic

DIMENSIONS.....1 $\frac{3}{4}$ "(H)  $\times$  6"(W)  $\times$  7"(D)

WEIGHT.....6 lbs.

**CONTROLS**

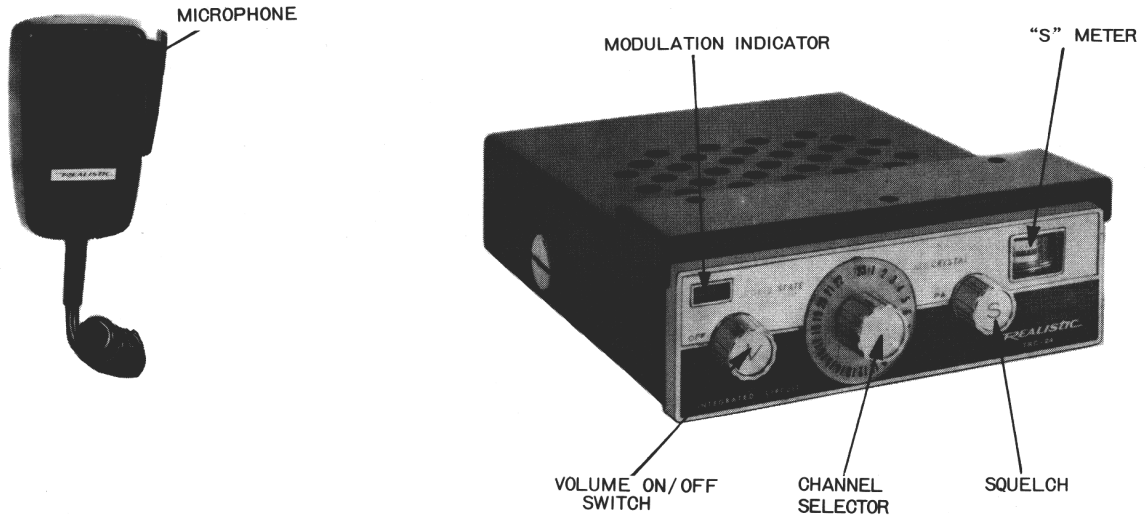

**Fig. 1**

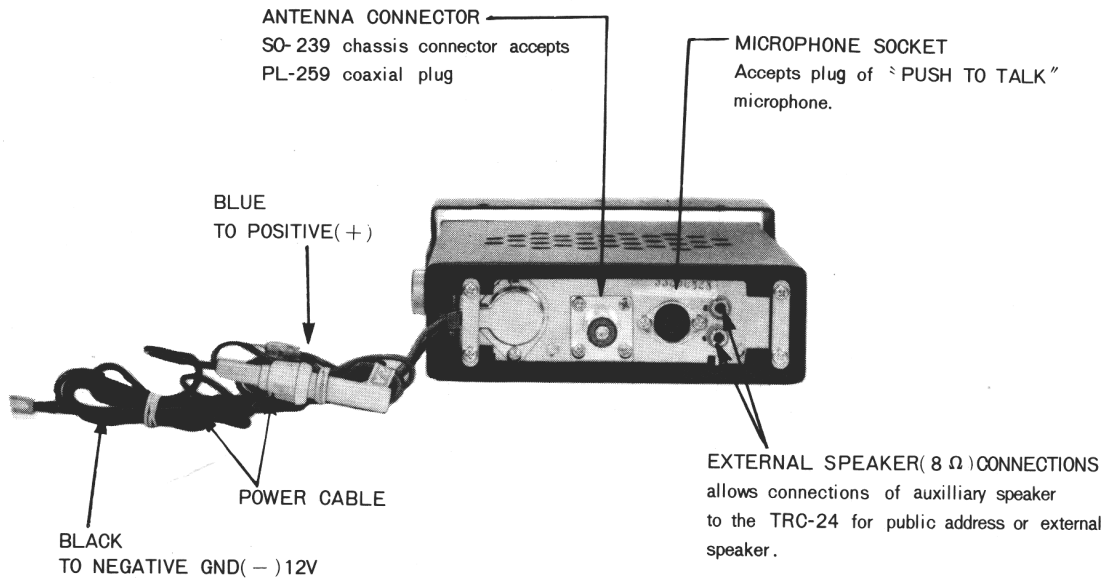

**BLOCK DIAGRAM**

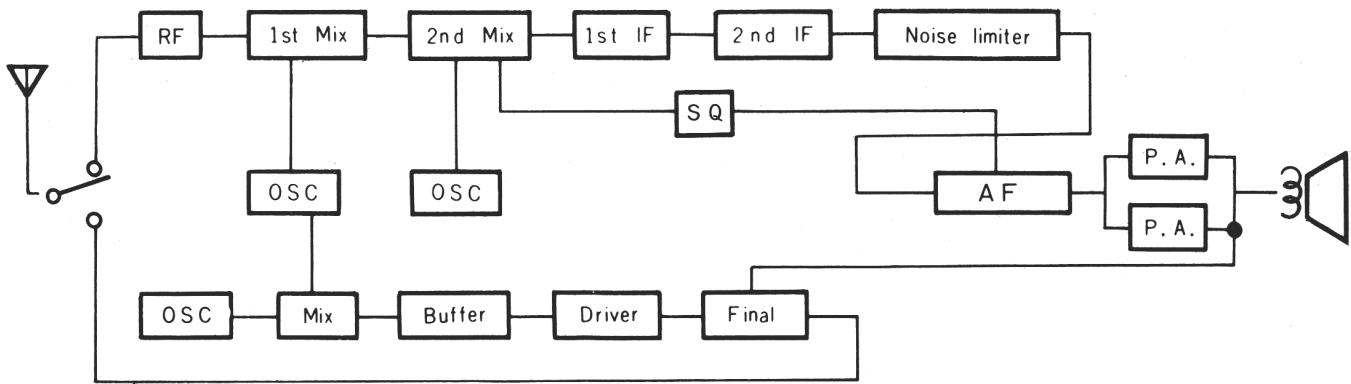

Fig. 3

**DISASSEMBLY**

**1. Removal of metal case**

After removing unit from the mounting bracket, remove four screws holding metal case as shown in Fig. 4 and slide metal case in the direction of arrow as shown in Fig. 5.

**2. Removal of speaker**

Remove two screws holding speaker as shown in Fig. 6.

**3. Removal of printed circuit board**

Remove soldered lug terminals fixed to circuit board as shown in Fig. 7.

METAL CASE HOLDING SCREWS

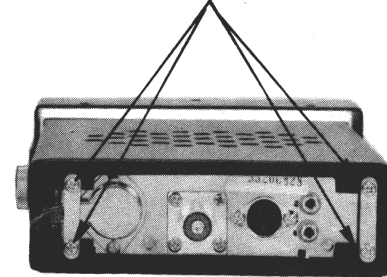

Fig. 4

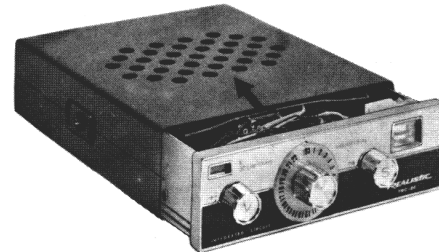

Fig. 5

SOLDERED LUG TERMINALS

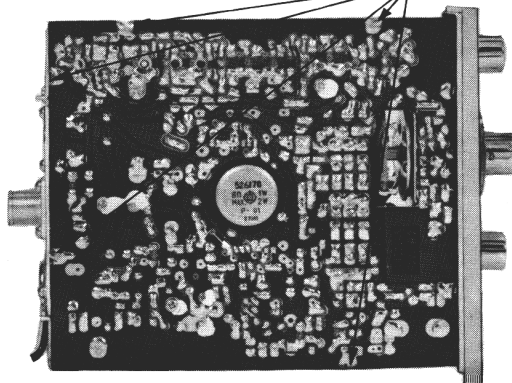
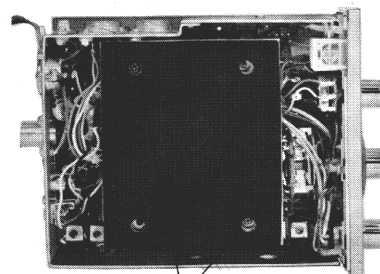

Fig. 7



SPEAKER HOLDING SCREWS

Fig. 6

**ALIGNMENT OF RECEIVER SECTION****EQUIPMENT REQUIRED**

Signal generator 455KHz and 27 MHz Band, 1,000 Hz,  
30%AM, Output Impedance 50 ohms  
AF Output Meter 8 ohms, 5 watts.  
DC power supply 13.2 volts, 1.5A.  
Oscilloscope, Frequency Meter or Counter.

**PROCEDURE**

Allow test equipment and set at least 15 minutes to warm up before starting the alignment.  
Output Level: Keep signal generator output low enough to prevent AGC overload (Below 2 volts on output meter).

Step	Signal Generator Connection	Signal Generator Frequency	Set Conditions	Output Meter Connection	Adjustment	Remarks
1	High side thru 0.01 $\mu$ F to base of Q3 & ground	455 KHz	Squelch: min. Vol: max.	From ext. SP. jack, J4	T6 thru T12	Adjust for max. output
2	To Ant. jack, J1	27.085 MHz (CH11)	Same as step 1	Same as step 1	T1 thru T5	Adjust for max. output
3	Same as step 2	Same as step 2	Same as step 1	Same as step 1	R23	Adjust for 2 volts output at signal generator output 0.25 $\mu$ V

**ALIGNMENT OF TRANSMITTER SECTION**

This transceiver meets all requirement of F. C. C. Rules and Regulations, Part 95. In order to operate the transceiver the user must be licensed. Obtaining an operator's license is a simple procedure. However, only those persons properly licensed by the F.C.C. are permitted to repair or adjust any malfunctioning unit found to be transmitting illegally (refer to F.C.C. Rules and Regulations, Part 95, Subpart D, Section 95.95).

**PROCEDURE**

Allow test equipment and set at least 15 minutes to warm up before starting the alignment.  
RF Output meter or 50 ohms HF dummy load must be connected to antenna jack.

Step	Set Condition	RF Output meter connection	Adjustment	Remarks
1	Transmitting non mod.	To Ant. jack, J1	T15 thru T20	Adjust for max. output
2	Same as step 1.	Readjust T19 as required for 5 watts of DC power input observed with DC milli-amp. meter connected between a cold point of choke coil L5 and ground.		
3	Same as step 1.	Finally check Frequency on all channels.		
4	Same as step 1.	Connect Field Strength Meter to antenna terminals and adjust T15 so that spurious radiation near 26 MHz is minimum.		

**TRANSISTOR VOLTAGE CHART**

1. POWER SUPPLY VOLTAGE=13.2V
2. ALL VOLTAGE MEASUREMENTS ARE WITH NO SIGNAL INPUT.

		R X	T X			R X	T X	
Q 1	B	1.5 V	—	Q10	B	—	2.7 V	
	E	0.85	—		E	—	2.05	
	C	7.0	—		C	—	8.7	
Q 2	B	1.8	—	Q11	B	—	1.1	
	E	1.45	—		E	—	0.9	
	C	8.0	—		C	—	8.6	
Q 3	B	1.9	—	Q12	B	—	2.2	
	E	1.4	—		E	—	1.85	
	C	7.9	—		C	—	12.5	
Q 4	B	0.75	—	Q13	B	—	—	
	E	0.1	—		E	—	0.8	
	C	6.3	—		C	—	14.0	
Q 5	B	1.65	—	Q14	B	—	—	
	E	1.0	—		E	—	—	
	C	8.0	—		C	—	11.8	
Q 6	B	2.5	2.5V	Q15	B	—	—	
	E	1.6	1.6		E	—	—	
	C	8.6	8.6		C	—	—	
Q 7	B	3.0	—	I C1	8	13.0	—	
	E	2.5	—		I C2	6	13.0	—
	C	8.5	—					
Q 8	B	12.4	12.0					
	E	12.5	12.1					
	C	0.06	0.03					
Q 9	B	12.4	12.0					
	E	12.5	12.1					
	C	0.05	0.02					

**INTERNAL VIEW**

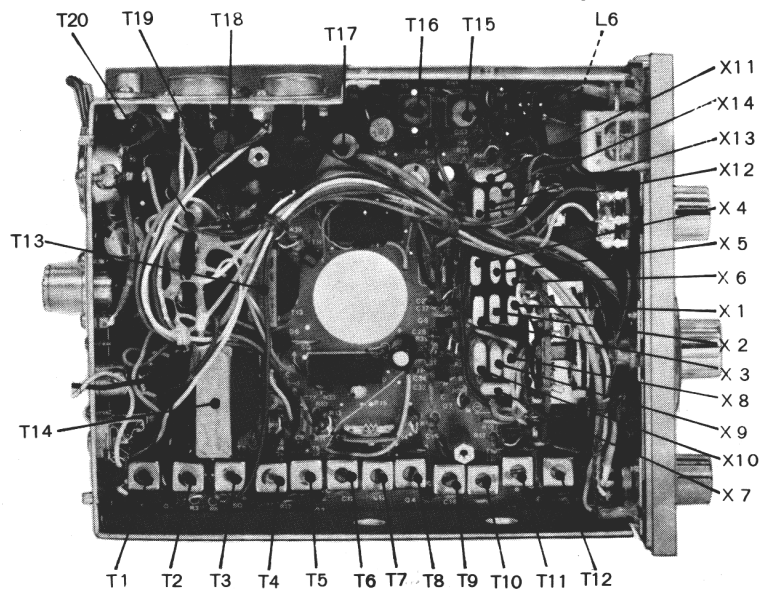

Fig. 8

**REPLACEMENT PARTS**

Symbol No.	Stock No.	Description	Symbol No.	Stock No.	Description
<b>CAPACITORS:</b>					
C 1	0275113	Mylar	C 76	0244018	Same as C21
C 2	0275113	Same as C1	C 77	0248708	Same as C5
C 3	0275113	Same as C1	C 78	0248706	Same as C69
C 4	0248632	Ceramic	C 79	0244018	Same as C21
C 5	0248708	Ceramic	C 80	0252513	Same as C23
C 6	0275113	Same as C1	Z 1	0234414	Cylindr ceramic capacitor ass'y
C 7	0248644	Ceramic	<b>RESISTORS:</b>		
C 8	0275113	Same as C1	R 1	0137905	Carbon film
C 9	0275113	Same as C1	R 2	0137957	Carbon film
C 10	0275113	Same as C1	R 3	0137810	Carbon film
C 11	0275113	Same as C1	R 4	0137853	Carbon film
C 12	0248632	Same as C4	R 5	0137851	Carbon film
C 13	0248632	Same as C4	R 6	0137951	Carbon film
C 14	0275114	Mylar	R 7	0137957	Same as R2
C 15	0275114	Same as C14	R 8	0137851	Same as R5
C 16	0248632	Same as C4	R 9	0137807	Carbon film
C 17	0248632	Same as C4	R 10	0137862	Carbon film
C 18	0275114	Same as C14	R 11	0137954	Carbon film
C 19	0275114	Same as C14	R 12	0137855	Carbon film
C 20	0276111	Mylar	R 13	0137851	Same as R5
C 21	0244018	Ceramic	R 14	0137958	Carbon film
C 22	0248724	Ceramic	R 15	0151803	Semi variable
C 23	0252513	Electrolytic	R 16	0137851	Same as R5
C 24	0276111	Same as C20	R 17	0137957	Same as R2
C 25	0244018	Same as C21	R 18	0137807	Same as R9
C 26	0275111	Mylar	R 19	0137805	Carbon film
C 27	0248716	Ceramic	R 20	0134397	Composition
C 28	0274111	Mylar	R 21	0131699	Composition
C 29	0248704	Same as C5	R 22	0151362	Semi variable
C 30	0248724	Same as C22	R 23	0137957	Same as R2
C 31	0274111	Same as C28	R 24	0137957	Same as R2
C 32	0245018	Ceramic	R 25	0137957	Same as R2
C 33	0248722	Ceramic	R 26	0137911	Carbon film
C 34	0248660	Ceramic	R 27	0137953	Carbon film
C 35	0244016	Ceramic	R 28	0137811	Carbon film
C 36	0244016	Same as C35	R 29	0137859	Carbon film
C 37	0245018	Same as C32	R 30	0137856	Carbon film
C 38	0275111	Same as C26	R 31	0137851	Same as R5
C 39	0252523	Electrolytic	R 32	0153631	Variable
C 40	0274116	Mylar	R 33	0137851	Same as R5
C 41	0252331	Electrolytic	R 34	0151627	Variable
C 42	0252232	Electrolytic	R 35	0137901	Carbon film
C 43	0275114	Same as C14	R 36	0134364	Composition
C 44	0275114	Same as C14	R 37	0137809	Carbon film
C 45	0248660	Same as C34	R 38	0137860	Carbon film
C 46	0248660	Same as C34	R 39	0137765	Carbon film
C 47	0274111	Same as C28	R 40	0137811	Same as R28
C 48	0248716	Same as C27	R 41	0134285	Composition
C 49	0248716	Same as C27	R 42	0134285	
C 50	0274111	Same as C28	R 43	0134291	
C 51	0248720	Ceramic	R 44	0137855	Same as R12
C 52	0275113	Same as C1	R 45	0137859	Same as R29
C 53	0248660	Same as C34	R 46	0137810	Same as R3
C 54	0248716	Same as C27	R 47	0137853	Same as R4
C 55	0248724	Same as C22	R 48	0137901	Same as R35
C 56	0275115	Mylar	R 49	0137801	Carbon film
C 57	0275111	Same as C26	R 50	0137855	Same as R12
C 58	0248712	Ceramic	R 51	0137859	Same as R29
C 59	0275111	Same as C26	R 52	0137769	Carbon film
C 60	0252525	Electrolytic	R 53	0137801	Same as R49
C 61	0274111	Same as C28	R 54	0137759	Carbon film
C 62	0275113	Same as C1	R 55	0137767	Carbon film
C 63	0244017	Ceramic	R 56	0137905	Same as R1
C 64	0248724	Same as C22	R 57	0137803	Carbon film
C 65	0248708	Same as C5	R 58	0134291	Same as R43
C 66	0274111	Same as C28	R 59	0137901	Same as R35
C 67	0248724	Same as C22	<b>TRANSISTORS:</b>		
C 68	0245019	Ceramic	Q 1	0573509	2SC535(A)
C 69	0248706	Ceramic	Q 2	0573486	2SC460(B)
C 70	0248732	Ceramic	Q 3	0573486	Same as Q2
C 71	0248732	Same as C70	Q 4	0573491	2SC454(B)
C 72	0275113	Same as C1	Q 5	0573491	Same as Q4
C 73	0252535	Electrolytic	Q 6	0573486	Same as Q2
C 74	0252621	Electrolytic	Q 7	0573486	Same as Q2
C 75	0245019	Same as C68	Q 8	0573040	2SB337(B)
			Q 9	0573040	Same as Q8
			Q 10	0573486	Same as Q2

# REALISTIC CAT.NO.21-124 SERVICE MANUAL

Symbol No.	Stock No.	Description	Symbol No.	Stock No.	Description	
Q 11	5320051	2SC717		0515017	Indicator	
Q 12	0573517	2SC150(T)		0526170	Speaker-8×12cm	
Q 13	0573519	2SC116(T)		0711405	Pan head screw-3mm ∅ × 5mm	
Q 14	0573541	2SC609(T)		0021093	Speaker plate	
Q 15	5321067	2SC458(B~D)		8021094	Speaker sheet	
D 1	0575005	Diode 1N60		0021250	Speaker cushion	
D 2	0575005	Same as D1		6160063	Cover sub assembly	
D 3	0575005	Same as D1		7710372	Spacer	
D 4	0575001	Diode 1N34A		8781440	Tapping screw-3mm ∅ × 10mm	
D 5	5330011	Zenner diode TR-9S		0047001	Washer	
D 6	5330041	Diode HR-5A		0693262	Insulating plate	
TH 1	0576031	Thermistor 13D27		6260145	Knob (VS) sub assembly	
X 1	0599783	Crystal resonator 37600MHz		6260146	Knob (VS) sub assembly	
X 2	0599784	Same as X1 37650MHz		6261703	Knob (CH) sub assembly	
X 3	0599785	Same as X1 37700MHz		7160323	Bracket	
X 4	0599786	Same as X1 37750MHz		0681290	Lock screw	
X 5	0599787	Same as X1 37800MHz		0647538	Fuse indicator	
X 6	0599788	Same as X1 37850MHz		0591138	Fuse (2A)	
X 7	0599792	Same as X1 10180MHz		0996037	Plastic sack	
X 8	0599791	Same as X1 10170MHz			<b>for Frame assembly</b>	
X 9	0599790	Same as X1 10160MHz		0681296	Frame	
X 10	0599789	Same as X1 10140MHz		0544408	Lug terminal	
X 11	0599796	Same as X1 10635MHz		0930155	Fiber washer-5mm ∅	
X 12	0599795	Same as X1 10625MHz		8711408	Pan head screw-3mm ∅ × 8mm	
X 13	0599794	Same as X1 10615MHz		8811114	Washer-3mm ∅	
X 14	0599793	Same as X1 10595MHz		8821114	Nut-3mm ∅	
IC 1	5350041	Hybrid IC FA6007T		0923542	Jack guide	
IC 2	5350041	Same as IC1		0543180	Earphone jack	
<b>TRANSFORMERS:</b>						
T 1	0317175	High frequency (R)	J 4,6	0541358	5P socket	
T 2	0317175	Same as T1	J 3	0541399	Antenna connector	
T 3	0317175	Same as T1	J 1	5610014	Rottery switch	
T 4	0322341	IF	S 1	0234414	Cylindric ceramic capacitor assembly	
T 5	0322341	Same as T4	Z 1	0047027	Cord cover	
T 6	0322146	IF		8781436	Tapping screw-3mm ∅ × 6mm	
T 7	0322146	Same as T6		0593585	Battery cord	
T 8	0322146	Same as T6		5740612	Earth cord	
T 9	0322146	Same as T6			<b>for Printed circuit board assembly</b>	
T 10	0322146	Same as T6		K 1	5640132	Relay
T 11	0322146	Same as T6		0681852	Radiator plate	
T 12	0322147	IF		0541354	Crystal socket	
T 13	0441114	Driver transformer 2kΩ:200Ω×2		7511692	Column	
T 14	0452047	Modulation transformer 50Ω:30Ω,8Ω		8812114	Washer-3mm ∅	
T 15	0317192	High frequency (T)		8711405	Pan head screw-3mm ∅ × 5mm	
T 16	0317193	High frequency (T)		0924928	Relay cover	
T 17	0317194	High frequency (T)		0625630	Spacer (F)	
T 18	0317195	High frequency (T)		7710042	Spacer (F)	
T 19	0317196	Filter coil		8715106	Pan head screw-2mm ∅ × 6mm	
T 20	5123007	Filter coil		8812231	Washer-2mm ∅	
T 21	5123008	Filter coil			<b>for Printed circuitboard assembly</b>	
<b>COILS:</b>						
L 1	0318545	Choke 1μH		5350041	Hybrid IC	
L 2	0318544	Choke 0.22μH		0924928	Relay cover	
L 3	5152015	Choke 12μH		K 1	5640132	Relay
L 5	0318546	Choke 22μH		0681852	Radiator plate	
L 4	0318546	Choke 2.2μH		0541354	Crystal socket	
L 6	0422018	Choke 1.5mH		7511692	Column	
<b>for Final assembly</b>						
	8832116	Hexagonal bolt-5mm ∅ × 6mm		8812114	Washer-3mm ∅	
	8811117	Washer-5mm ∅		8711405	Pan head screw-3mm ∅ × 5mm	
	8813127	washer-5mm ∅		0625630	Spacer (F)	
	8821117	Nut-5mm ∅		7710042	Spacer (F)	
	8785720	Tapping screw-5mm ∅ × 20mm		8715106	Pan head screw-2mm ∅ × 6mm	
	5420014	Microphone		8812231	Washer-2mm ∅	
	5740171	Microphone plug		0593603	Cord	
	0044361	Escutcheon sub assembly				
	0681614	Lamp holder				
	0636390	Rubber plate-8mm ∅				
PL 1	5760072	Lamp				
PL 23	5760071	Lamp				
	0711306	Pan head screw-2.6mm ∅ × 5mm				



**A PRODUCT OF RADIO SHACK**

DIVISION OF TANDY CORPORATION

Printed in Japan

5/70 0028